

**COMMISSIONING OF THE CMS EXPERIMENT WITH COSMIC RAYS**

# Performance of CMS hadron calorimeter timing and synchronization using test beam, cosmic ray, and LHC beam data

---

**CMS Collaboration**

**ABSTRACT:** This paper discusses the design and performance of the time measurement technique and of the synchronization systems of the CMS hadron calorimeter. Time measurement performance results are presented from test beam data taken in the years 2004 and 2006. For hadronic showers of energy greater than 100 GeV, the timing resolution is measured to be about 1.2 ns. Time synchronization and out-of-time background rejection results are presented from the Cosmic Run At Four Tesla and LHC beam runs taken in the Autumn of 2008. The inter-channel synchronization is measured to be within  $\pm 2$  ns.

**KEYWORDS:** Calorimeters; Large detector systems for particle and astroparticle physics

**ARXIV EPRINT:** [0911.4877](https://arxiv.org/abs/0911.4877)

---

## Contents

<b>1</b>	<b>Introduction</b>	<b>1</b>
<b>2</b>	<b>CMS hadron calorimeter description</b>	<b>2</b>
2.1	Sources of timing variation and uncertainty	2
<b>3</b>	<b>HCAL time reconstruction</b>	<b>4</b>
<b>4</b>	<b>Detector timing/synchronization commissioning</b>	<b>4</b>
4.1	H2 beam test data	5
4.2	LHC beam data	6
<b>5</b>	<b>Impact of timing in analysis</b>	<b>9</b>
5.1	Impact on out-of-time background	10
5.2	Impact on physics processes	12
<b>6</b>	<b>Summary</b>	<b>13</b>
	<b>The CMS collaboration</b>	<b>15</b>

---

## 1 Introduction

The primary goal of the Compact Muon Solenoid (CMS) experiment [1] is to explore particle physics at the TeV energy scale exploiting the proton-proton collisions delivered by the Large Hadron Collider (LHC) [2]. The central feature of the CMS apparatus is a superconducting solenoid, of 6 m internal diameter, providing a field of 3.8 T. Within the field volume are the silicon pixel and strip tracker, the crystal electromagnetic calorimeter (ECAL) and the brass/scintillator hadron calorimeter (HCAL). Muons are measured in gas-ionization detectors embedded in the steel return yoke. In addition to the barrel and endcap detectors, CMS has extensive forward calorimetry.

The primary purpose of the HCAL is the measurement of hadronic energy from collisions in CMS. In addition to the energy measurement, the HCAL is also able to perform a precise time measurement for each energy deposit. Precise time measurements are valuable for excluding calorimeter noise and energy deposits from beam halo and cosmic ray muons. Time information can also be valuable for identifying new physics signals such as long-lived particle decays and slow high-mass charged particles [3].

This paper is organized as follows. Section 2 reviews the pertinent details of the HCAL construction and their fundamental impact on timing resolution. Section 3 discusses the method used to extract a time value from the digitized HCAL signal. In section 4, the validation of the method is presented based on measurements in test beam and initial beam operations of the LHC in September 2008. Section 5 details the performance of timing filters in the suppression of non-collision-based backgrounds and the effect these timing filters have on simulated physics events.

## 2 CMS hadron calorimeter description

A detailed description of the HCAL can be found elsewhere [1]. Briefly, the HCAL consists of a set of sampling calorimeters. The barrel [4] and endcap ([1], pp. 131–137) calorimeters utilize alternating layers of brass as absorber and plastic scintillator as active material. The scintillation light is converted by wavelength-shifting fibers embedded in the scintillator and channeled to hybrid photodiode detectors via clear fibers. The outer calorimeter [5] utilizes the CMS magnet coil/cryostat and the steel of the magnet return yoke as its absorber, and uses the same active material and readout system as the barrel and endcap calorimeters. The forward calorimeter is based on Cherenkov light production in quartz fibers and is not discussed in this paper, due to its different signal time structure.

The HCAL is segmented into individual calorimeter cells along three coordinates,  $\eta$ ,  $\phi$ , and depth. The  $\phi$  coordinate is the azimuthal angle and  $\eta$  is the pseudorapidity. The depth is an integer coordinate that enumerates the segmentation longitudinally, along the direction from the center of the nominal interaction region. The layout of the barrel, endcap and outer calorimeter cells is illustrated in figure 1. Most cells include several scintillator layers; for example, in most of the barrel all 17 scintillator layers are combined into a single depth segment.

Calorimetric measurements are acquired using the HCAL readout electronics, shown schematically in figure 2. Each electronics channel collects and processes the signal of a single cell. One calorimetric measurement is acquired with each LHC clock tick (25 ns) from each cell in the HCAL. This defines a “time sample”. The HCAL front-end electronics does not sample the signal instantaneously; rather, the electric current collected from the photodetectors is integrated over each clock period and then sampled. As a consequence, the sample clock is most commonly termed the “integration clock”.

The integration clock can be delayed with respect to the LHC clock on a per-channel basis by programmable settings, referred to as sampling delay settings, that have a resolution of 1 ns. The purpose of these settings is to compensate for channel-dependent timing variations at the hardware level, and to permit the energy estimate from each LHC crossing to be reconstructed consistently for use in the Level-1 trigger for all pulse amplitudes and for all channels. They also provide an initial coarse timing calibration.

### 2.1 Sources of timing variation and uncertainty

There are two dominant sources of channel-dependent timing variation: the different time-of-flight of particles from the interaction region to each HCAL cell and the different signal propagation times through optical fibers of different lengths. Within the barrel, the first effect tends to skew reconstructed times later for higher  $\eta$ . The second effect, because of the location of the front-end electronics, tends to skew reconstructed times earlier for higher  $\eta$ , and this is the effect that dominates. The combination of these two effects induces a timing dependence on  $\eta$ , with a spread in each half-barrel of about 15 ns. Smaller variations as a function of  $\phi$  are induced by clock distribution differences and other effects. By applying proper sampling delay settings, this spread can be reduced substantially. In addition, the reconstruction software utilizes a set of per-channel calibration constants to synchronize the mean timing of energy measurements to less than 1 ns.

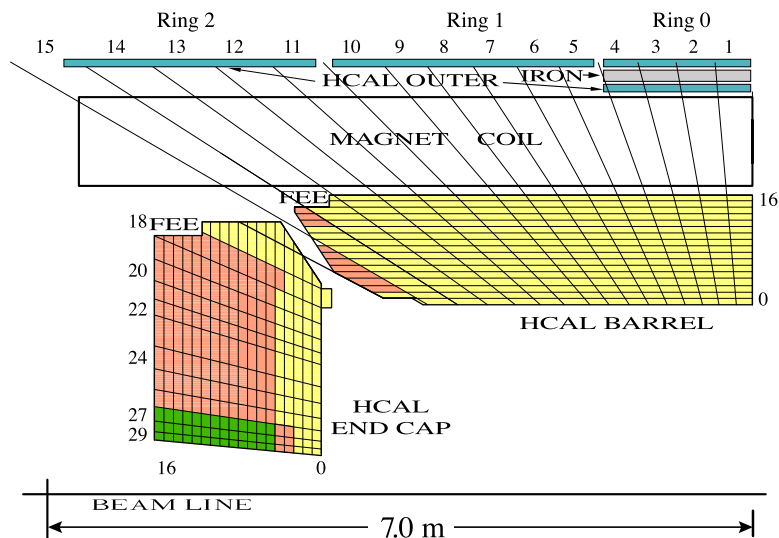

**Figure 1.** A quarter slice of the CMS HCAL detectors. The right end of the beam line is the interaction point. FEE denotes the location of the Front End Electronics for the barrel and the endcap. In the diagram, the numbers on the top and left refer to segments in  $\eta$ , and the numbers on the right and the bottom refer to scintillator layers. Colors/shades indicate the combinations of layers that form the different depth segments, which are numbered sequentially starting at 1, moving outward from the interaction point. The outer calorimeter is assigned depth 4. Segmentation along  $\phi$  is not shown.

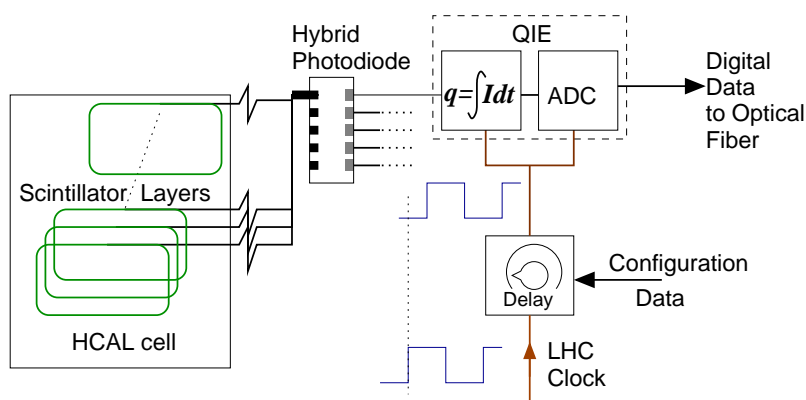

**Figure 2.** A schematic view of the HCAL front-end readout electronics. The readout for one HCAL cell/channel is shown. Key features are the optical summing of layers, charge integration followed by sampling and digitization, and per-channel programmable delay settings. The "QIE" [6] is a custom chip that contains the charge-integrating electronics with an analog-to-digital converter (ADC). The Configuration Data input defines the sampling delay settings.

Fiber lengths also differ within each calorimeter cell along the radial coordinate, but in this case there are no means available to compensate for these differences. Since the signals from all the scintillator layers comprising one cell are optically summed, and the optical path lengths are not

equalized across the layers, the resulting signal is smeared in time. For hadrons, which exhibit large shower-to-shower fluctuations in longitudinal development, the optical summing of layers imposes a limit on the timing resolution, estimated to be approximately 1 ns. For signals with uniform energy deposit in each layer (such as those arising from the beam-collimator interactions described later), the resolution is not limited by shower-development fluctuations and can be significantly smaller than 1 ns.

### 3 HCAL time reconstruction

When the Level-1 trigger system [7] identifies an event of potential physics interest, a set of 10 consecutive time samples per channel containing the triggered bunch-crossing is collected and sent to the high-level trigger software. The capability of the HCAL system to reconstruct the arrival time of the signal more precisely than the sample clock period derives from the spread of the HCAL pulse shape over three to four time-integrated samples (figure 3). The time reconstruction software calculates a first order time estimate from a center-of-gravity technique using the three samples centered on the peak,

$$\text{Weighted peak bin} = \left[ \frac{(p-1)A_{p-1} + pA_p + (p+1)A_{p+1}}{A_{p-1} + A_p + A_{p+1}} \right] \times C \quad , \quad (3.1)$$

where  $A_i$  represents the amplitude of an arbitrary time sample  $i$ , and  $p$  is the value of  $i$  such that  $A_p$  is maximum over the set of samples. In the case of multiple samples with the same amplitude, the earliest one is picked. The constant  $C$  is an amplitude-independent normalization constant that rescales the first order estimate to a range from zero to one. The weighted peak bin is then used to determine a second order correction (figure 4) that compensates for the asymmetry of the pulse shape, yielding the phase of the signal within the peak time sample. An additional additive correction determined in test bench measurements ([1] pp. 152–154),

$$\Delta_{\text{slew}} = (3.59 \text{ ns}) \log_{10} \left[ \frac{1 \text{ TeV}}{E (\text{TeV})} \right] \quad , \quad (3.2)$$

compensates for an electronics effect that delays the measured time for signals with pulse energy  $E$  less than 1 TeV. The maximum value of  $\Delta_{\text{slew}}$  is taken to be 10 ns.

This algorithm yields accurate time measurements except when consecutive bunch crossings yield energy measurements of similar amplitude within the same HCAL cell. Such events can be identified by their anomalous pulse shape, and the time measurement can be marked as having poor resolution.

### 4 Detector timing/synchronization commissioning

This section describes the performance characterization and commissioning results for HCAL timing and synchronization. Beam tests at the CERN SPS H2 area (hereafter referred to as “test beam”) produced key results [8] that define the timing performance of the HCAL barrel and endcap; these results are presented first. The results from the LHC 2008 beam commissioning data for the barrel, endcap and outer calorimeters are then described; these results validate and extend the initial synchronization calibration constants determined from beam tests.

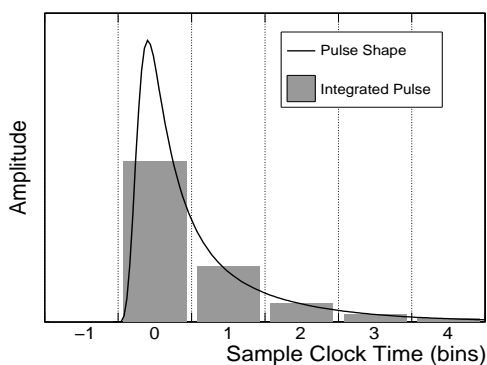

**Figure 3.** The HCAL pulse shape and its relation to the integrated samples. Time sample 0 is defined by the trigger for a nominally synchronized event.

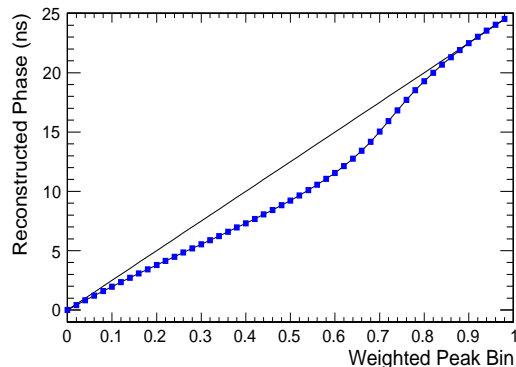

**Figure 4.** The correction function applied in signal reconstruction software to compensate for pulse shape asymmetry. The straight line represents a trivial correction function for a perfectly symmetric pulse.

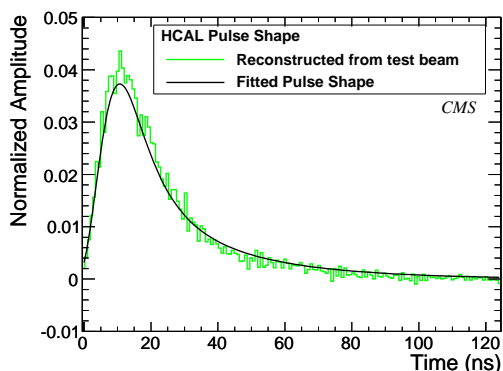

**Figure 5.** Average pulse shape reconstructed for the HCAL from H2 beam test data using 300 GeV pions.

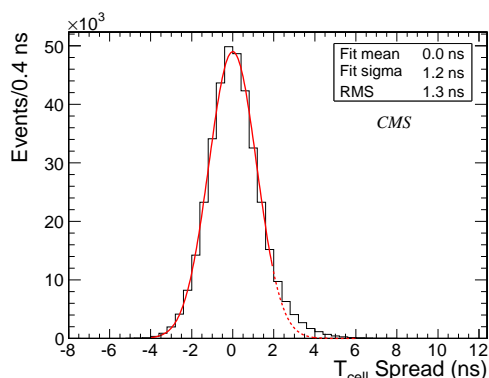

**Figure 6.** Resolution performance of the HCAL barrel from 150 GeV pion test beam data. The non-Gaussian tail is attributed to beam contamination from electrons and photons that shower in the first layers of the HCAL and thus reconstruct with later signal times.

#### 4.1 H2 beam test data

For test beams in 2004 and 2006, a section of the HCAL barrel was mounted on a table that was adjustable in  $\eta$  and  $\phi$  coordinates. The unit under test was exposed to pion beams with energies in the 3–300 GeV range. The delivered beam was asynchronous with the 40 MHz integration clock, so all relative sampling phases could be investigated. From these tests the following important timing benchmarks for the HCAL were accurately measured.

The HCAL pulse shape was successfully reconstructed from data. Since the pulse is integrated before it is digitized, this required a numerical differentiation technique that utilized the phase between particle arrival and the integration clock, as measured by a time-to-digital converter (TDC) running at 32 times faster than the sample clock rate. This allowed the separation of the data sample into subsamples  $S_n$ , with  $n = 1 \dots 32$  ordered by TDC phase. These subsamples represent the integration of the pulse  $P(t)$  shifted successively by the TDC bit resolution ( $\Delta t = 0.78$  ns). Then,

$$\langle I_m \rangle_{S_{n+1}} - \langle I_m \rangle_{S_n} \simeq \int_{\tau}^{\tau+\Delta t} P(t) dt \simeq P_{\text{avg}}(\tau) \Delta t \quad , \quad P_{\text{avg}}(\tau) \simeq \left. \frac{\Delta \langle I \rangle}{\Delta t} \right|_{\tau} \quad , \quad (4.1)$$

where  $\langle I_m \rangle_{S_n}$  is the average integrated amplitude for time bin  $m$  of data subsample  $S_n$ ,  $\tau = m\Delta t$  is the phase within that time bin, and  $P_{\text{avg}}(\tau)$  is the average value of  $P(t)$  over  $\Delta t$  at  $t = \tau$ . Equation (4.1) is valid to reconstruct the first 25 ns of the pulse shape, for which  $m = 0$ . For each remaining 25 ns interval, bin  $m$  is incremented and a second integral term appears in the equation that corresponds to the  $\Delta t$ -sized portion of the pulse “leaving” the time bin. In this manner, the whole pulse was reconstructed to approximately 0.8 ns resolution, as is shown in figure 5. The functional form matched to these results is used in the simulation of the CMS detector response, and also to determine the second-order time reconstruction correction function (figure 4).

To measure both the channel-to-channel variations and the hadronic timing resolution limit of the HCAL, a 150 GeV pion beam was directed at every cell in the unit under test. From these data the variation of the timing of signals as a function of  $\eta$  between HCAL cells in the barrel was mapped. As the test setup mimicked the geometry and fiber lengths of the final barrel detector, a set of final sampling delay settings could be derived. Section 4.2 discusses the performance of these settings with LHC beam data. The HCAL timing resolution was determined by removing the channel-to-channel variations and combining the data. A Gaussian function was then fitted to the distribution of the leading energy deposit from each event, producing a best-fit width of  $\sigma = 1.2$  ns (figure 6). This result is consistent with the expected effect of the uncorrectable sources of timing spread described in section 2.1, averaged over many hadronic shower events. The measured resolution is consistent across the full set of channels studied.

The variation of HCAL timing resolution as a function of energy was also measured with pion beam data. In this measurement the HCAL unit under test was paired with its corresponding section of the ECAL in front, as in the CMS detector. Events in two categories were considered: those with no interaction in the ECAL ( $< 1$  GeV energy deposited) and those with a significant interaction ( $> 5$  GeV energy deposited). The results indicate that the presence of the ECAL does not substantially alter the timing resolution of the HCAL as a function of energy (figure 7(a)). CMS software was subsequently adjusted by smearing the times of simulated HCAL energy deposits so that simulated data of the test beam configuration exhibited the same energy-dependent time resolution (figure 7(b)).

## 4.2 LHC beam data

Data from LHC beam commissioning were used to validate the barrel sampling delay settings derived from test beam data, and to derive settings to compensate for the  $\eta$  dependence of timing in the endcap and outer calorimeters. Data from LHC beam operations were recorded for the first time on September 10, 2008. In preparation for the arrival of LHC beam at CMS, the  $\eta$ -dependent

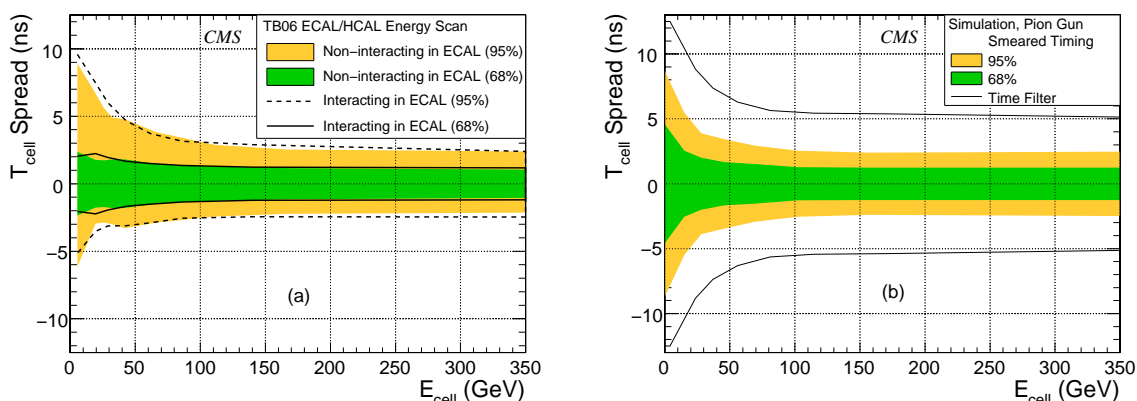

**Figure 7.** (a) Timing resolution as a function of energy measured during test beam runs in 2006, showing the consistency of time reconstruction for particles that begin showering in the ECAL (lines) and those that do not (areas). (b) Timing resolution as a function of energy of reconstructed deposits generated from CMS simulations. The lines marked “Time Filter” indicate the boundaries of a timing window discussed later and used to accept or reject deposits for distinguishing signal from background.

sampling delays measured from test beam were loaded into the barrel front-end electronics. These delay values had been calculated to synchronize channels for data from collisions. Delay values for endcap and outer sectors were set to zero, since no timing measurements for these sectors were available at the time.

The LHC beam delivered to CMS consisted of a single 450 GeV proton bunch circulating in the ring, first in one direction and then in the other. The LHC beam was also steered into collimators located 150 m upstream in either direction of the detector interaction point. Such events are referred to as “beam splash” events. Because of the large amount of material in the collimator and along the path of the secondaries, only muons were able to penetrate the entire CMS detector and form the signal in the calorimeter system. The millions of muons produced from the dumping of the beam passed through the entire detector, depositing large signals in every cell of the HCAL, with equivalent energy ranging between hundreds of GeV to a few TeV. A schematic representation of the geometry of the “beam splash” setup is shown in figure 8.

The signal from “beam splash” muons has a well-defined time with respect to the arrival of the LHC bunch and to the LHC clock. The time-of-flight of the muons from the collimators to the geometrical centers of each cell was calculated and used to predict the expected timing versus  $\eta$  for all HCAL cells. The data were averaged over all  $\phi$  values at each  $\eta$  value to obtain an HCAL  $\eta$  timing profile. The resulting distribution of the differences between the measured and predicted times is shown in figure 9(a). The timing measurements for the barrel region are distributed around zero within  $\pm 1$  ns, demonstrating the correctness of the delay settings calculated from beam tests. The timing for the endcap before any phase corrections exhibits an average time difference that is 10 ns later than the barrel. The x-shaped pattern and the structure at  $|\eta| > 1.4$  in the outer calorimeter are understood to originate from the pattern of optical fibers in the scintillator trays and the positioning of readout electronics.

From these data,  $\eta$ -dependent sampling delays were derived for the endcap and outer calorimeters. The delays were loaded into the front-end electronics, and new “beam splash” data were taken

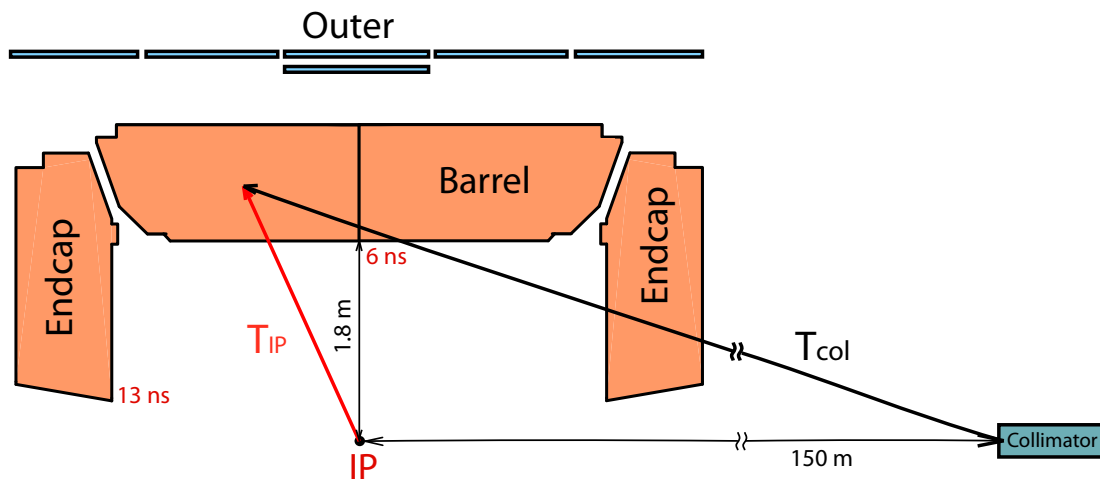

**Figure 8.** A schematic view of the geometry of “beam splash” events. This geometry was used to predict the timing of energy deposits and thereby highlight channels in the HCAL that required synchronization. The times  $T_{IP}$  and  $T_{col}$  refer to the times-of-flight of relativistic particles from the interaction point (IP) and collimator, respectively. The timing numbers give the specific values of  $T_{IP}$  to the front faces of the barrel and endcap.

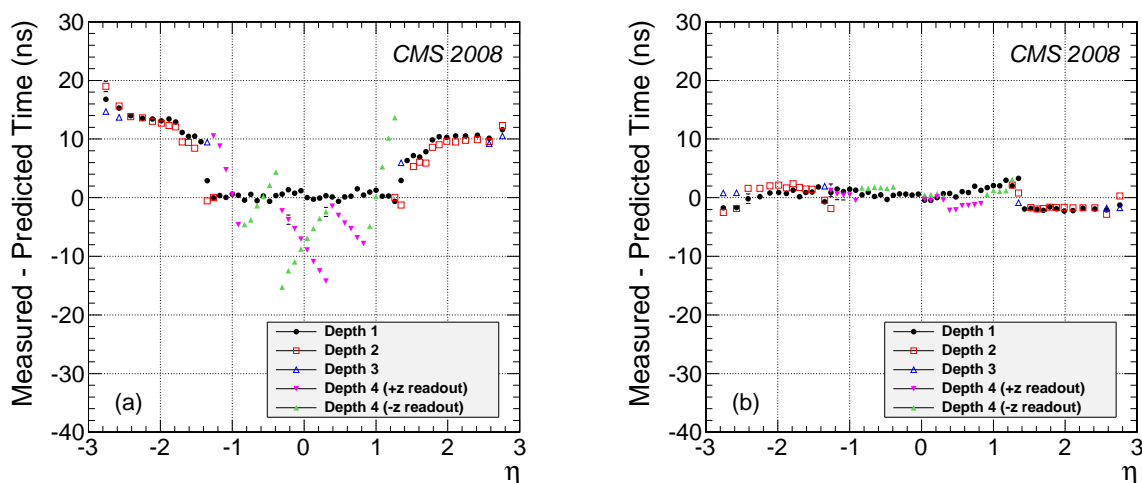

**Figure 9.** Difference between measured and predicted time as a function of  $\eta$  from LHC “beam splash” events. (a) Per-channel delay settings that compensate for timing variations along  $\eta$  were loaded into the front-end electronics for the barrel (depths 1–2,  $|\eta| < 1.4$ ) but not for the endcap (depths 1–3,  $|\eta| > 1.4$ ) or outer (depth 4) calorimeters. Events from both  $+z$  and  $-z$  directions are included. (b) Compensating sample delay settings were loaded for all three calorimeters, barrel, endcap and outer. Only events from  $+z$  direction were available and are included.

from interactions on the  $+z$  collimator on September 18, 2008. The same analysis used to derive the original delays was repeated on these data; the results are shown in figure 9(b). Some outer calorimeter data points are omitted from the plot due to a technical issue at the time of data-taking that has since been resolved.

Figure 9(b) shows that, as a result of the sampling delay derivation from “beam splash” data, barrel and endcap channel synchronization along  $\eta$  is verified to within  $\pm 2$  ns. Although “beam splash” event data from both directions were used to derive the settings for endcap and outer, only event data from the  $+z$  direction were available to verify these settings. For this reason figure 9(b) exhibits systematic deviations, particularly near the barrel-endcap boundary. For cells that are significantly slanted relative to the arrival direction of the muons, the “beam splash” will illuminate the various layers of the cell at different times. The effect is canceled when considering events from both directions. Additional possible systematic effects, such as an offset in timing between the positive and negative endcaps, will be studied with future “beam splash” data from both directions.

The results shown in the last two sections indicate that the methods of time reconstruction and synchronization are effective both in the H2 test beam environment and with the HCAL integrated in CMS. The final offline time corrections, which will be determined with collision data when they become available, are expected to provide synchronization with a spread in the per-channel mean times of less than 1 ns.

## 5 Impact of timing in analysis

Many interesting physics processes that the CMS experiment was designed to study or discover contain the signature of an undetected particle. Examples include the Standard Model neutrino and the lightest stable particle in several hypothetical supersymmetric particle spectra. Such particles would pass undetected through CMS, carrying some of the energy and momentum that would otherwise counterbalance the other collision products registered in the calorimeters. At hadron colliders, the initial energy and longitudinal momentum of the colliding hadronic constituents are not known, but the initial transverse momentum is known to be negligible in comparison and can be treated as zero. Therefore, the benchmark used to infer the existence of an unobserved particle in any given event is the calorimetric missing transverse energy [9].

The missing transverse energy (MET) is reconstructed from calorimeter towers, which are reconstructed objects containing the sum of the signals from HCAL and ECAL cells at the same  $(\eta, \phi)$  coordinates. The MET is calculated by taking the magnitude of the vector sum of the transverse energy contributions of towers,

$$MET = \sqrt{\left(\sum_{\text{towers}} E_i \sin \theta_i \cos \phi_i\right)^2 + \left(\sum_{\text{towers}} E_i \sin \theta_i \sin \phi_i\right)^2}, \quad (5.1)$$

where  $E_i$  and  $(\theta_i, \phi_i)$  are the energy and angle coordinates of each tower.

Multiple complications arise in the accurate measurement of MET. The energies of jets or leptons can be mismeasured due to detector miscalibration or shower fluctuations in the dead material of the detector. The MET in a collision event can also be affected by energy deposits in HCAL cells from non-collision sources. Without a separate identification of these sources the energy will be misassigned to the event of interest, inducing fake MET. Example sources include cosmic ray muons, detector noise, and beam halo.

This section explores the use of HCAL timing as a potential tool to identify sources of fake MET. The CMS design ensures that the phase of collision products relative to the LHC clock is

fixed to high precision. The results presented in section 4 indicate that the HCAL system is capable of being synchronized to approximately 1–2 ns. Since sources of fake MET are generally uncorrelated with the collision event one can significantly suppress their contributions to MET using their reconstructed times. In the case of beam halo particles, although their arrival is correlated to the arrival of proton bunches in the beam, the exact arrival time to a given detector cell is generally distinguishable from the arrival time of particles produced in the interaction region.

### 5.1 Impact on out-of-time background

The strategy for using timing to reject backgrounds is implemented at the level of reconstructed cell measurements, rather than higher-level objects like hadronic jets or MET. It is expected that during data taking triggered events will contain collision data in around 1000 HCAL cells, over which additional out-of-time energy deposits may be superimposed. These out-of-time deposits can be individually removed from the calculation of MET rather than rejecting the entire event. The application of such a technique is appropriate for the analysis of prompt physics signals, while an analysis focused on long-lived particles might perform the reverse selection, preferring energy deposits that are out of time.

The sources of irreducible timing uncertainty described in section 2 will limit the tightness of the timing requirements that can be applied. The degradation of time resolution for low energy particles requires that any time filtering must take this energy dependence into account in order to avoid biasing the measurement. The timing filter for individual cell measurements was defined according to the resolution measurement shown in figure 7. The filter, shown in figure 7(b), is made wider than the 95% confidence level by a factor of two, to allow for the additional uncertainty associated with the spread of primary vertex locations, particularly for the endcap calorimeters. The effect of the primary vertex distribution is expected in collision data and included in the CMS simulation but not included in figure 7(b), which is intended to replicate the results of test beam data. The larger envelope is also considered a conservative choice for startup when the detector is expected to be less well calibrated, and other sources of irreducible uncertainty will not yet have been identified. For hits with energies below 4 GeV, no requirement is applied except that the peak amplitude should be in the triggered data sample.

Using the strategy outlined above, the timing filter was then applied to two datasets: beam background data collected during LHC beam commissioning in September 2008 and cosmic ray muon and CMS detector noise background data collected in October and November 2008, during the month-long data-taking exercise known as the Cosmic Run At Four Tesla (CRAFT) [10]. For each event, the MET was calculated twice for comparison. One calculation of MET used all energy deposits (referred to as “unfiltered”), while the second did not include energy deposits with a measured time outside the window (referred to as “time-filtered”). The unfiltered measurements include energy depositions in bunch crossings other than the triggered one, as a consequence of the triggering and reconstruction algorithms used during these periods.

The comparison between the unfiltered MET and the time-filtered MET for HCAL-triggered events, cosmic ray events, and beam events is shown in figure 10. The HCAL-triggered events were collected using a Level-1 trigger in which a single calorimetric tower energy exceeds a 5 GeV threshold. Therefore, this sample includes photo-detector and other instrumental noise events [11]. Events with a Level-1 muon trigger were removed from the sample. The cosmic ray muon events

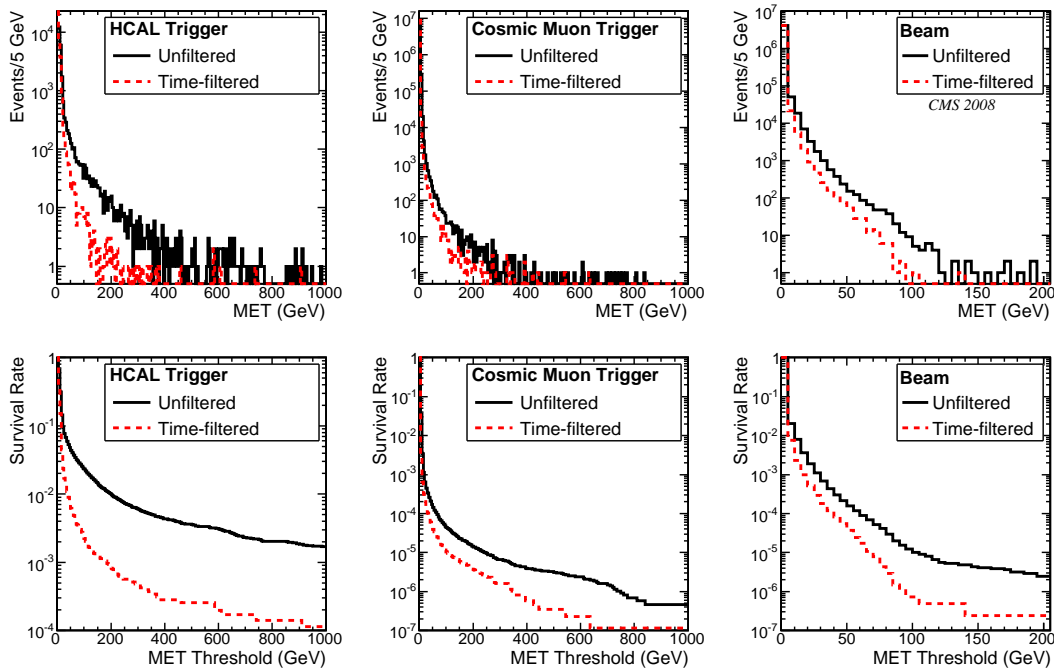

**Figure 10.** Time filter performance on MET for HCAL-triggered noise events, events selected by the cosmic muon trigger, and events from beam operations. The top plots show the MET distributions calculated twice for each event, once using all measurements (unfiltered) and once using only in-time measurements (time-filtered). The bottom plots show the fraction of events that survive as a function of a MET threshold applied to both unfiltered and time-filtered measurements.

were collected during CRAFT with a Level-1 trigger in which a single muon is identified by the CMS muon stations. The beam events were taken with a single circulating 450 GeV proton bunch on September 18, 2008. All events from this sample are included in the plots regardless of trigger source, which could be beam pickup, coincidence of scintillator or forward calorimeter energy deposits, or any of several muon triggers. The beam sample thus includes beam halo and beam-gas events as well as cosmic ray muons and accidental overlaps with calorimeter noise events. In all cases, the physical MET value would be zero, so a net migration of events from high MET to low MET is expected when comparing the unfiltered and time-filtered MET distributions.

Figure 10 also shows the fraction of events that survive a minimum MET criterion as a function of the threshold value. This was done for both the time-filtered and unfiltered distributions for each background type. Figure 10, therefore, indicates that a reduction by a factor of 5–10 in the rate of events with fake MET can be achieved with time filtering for all three sources of background studied. This rejection factor is consistent with the ratio of the filter window width to the width of the four time samples considered in the reconstruction of an HCAL measurement. The fake MET production for all three samples is due predominantly to a small number of high energy measurements, against which the filter is most effective.

The filter can be tuned to enhance further the background rejection performance. More sophisticated algorithms could be employed to filter clusters of cells with mixed in-time and out-of-time

signals if the members of the cluster share common characteristics that identify them as background. For instance, beam halo muons may create a cluster of deposits in consecutive cells along  $\eta$  for the same  $\phi$ , most of which will be out-of-time. This pattern, once identified, could allow the removal of nominally in-time background as well.

## 5.2 Impact on physics processes

To estimate the impact of this technique on signals that have not yet been produced in the CMS detector, studies have been performed on two simulated processes, one that contains MET at the event generator level and a second that does not. An interesting example of the first case is the real MET induced by the hypothetical weakly-interacting supersymmetric (SUSY) [12] particle called the neutralino. By applying an ill-chosen time filter, one may underestimate the MET induced by the neutralino by filtering out calorimetric deposits associated with the recoiling jet. A typical process without significant MET at generator level is a hadronic dijet event, commonly referred to as a QCD dijet event. In this case one may also infer a (fake) MET in an event in which no MET is expected, causing a tail in the high end of the MET distribution. Therefore, an ill-chosen time filter could degrade the discovery potential of a neutralino search by reducing the measured MET of the neutralino signal while simultaneously increasing the (fake) MET of a major background.

To assess whether the chosen timing cuts induce a bias on processes with significant MET, the timing filter was applied to a sample of simulated events containing neutralinos and generated under the assumptions of  $\sqrt{s} = 10\text{TeV}$  and no overlapping events ( $L = 10^{30} \text{ cm}^{-2}\text{s}^{-1}$ ). The selected SUSY sample was generated using ISASUSY [13] and Pythia 6.4 [14] at a “low mass” point referred to as “LM1” [15] in the phase space of one favored model of SUSY known as mSUGRA [12]. The early discovery or exclusion of this point is potentially within reach of the LHC experiments given the integrated luminosity expected from the first physics run. The left plots in figure 11 show that the same energy-dependent timing window used in section 5.1 preserves MET distributions for simulated SUSY events with high efficiency.

The impact of the timing filter for QCD dijet events was also studied. The QCD dijet process was generated by Pythia for a range of hard scattering scales  $15\text{GeV}/c < \hat{p}_T < 3\text{TeV}/c$  with same center-of-mass and luminosity assumptions as the SUSY sample. While these events have no inherent MET, mismeasurements and dead material will result in the reconstruction of some MET in these events, particularly for events with large total transverse energy. The results for the QCD dijet sample are shown in the right column of figure 11 and indicate that the MET distribution is maintained by the filtering process. It is important to note that this filter is not intended to remove QCD backgrounds, which are inherently in-time. The point of the comparison is to verify that an increase in MET is not inadvertently created by the filtering process.

In order to apply the time filter to analysis of physics processes, actual performance of the filter will have to be rederived on collision data using processes such as  $W \rightarrow \ell\nu$  events containing jets. The generation of fake MET will be measured using processes such as  $\gamma + \text{jet}$ , where no MET is expected and the recoil against the photon provides good control of possible jet energy mismeasurement. The efficiency of background rejection can be further studied using dijet event samples containing a cosmic ray or beam halo muon as identified by the muon system.

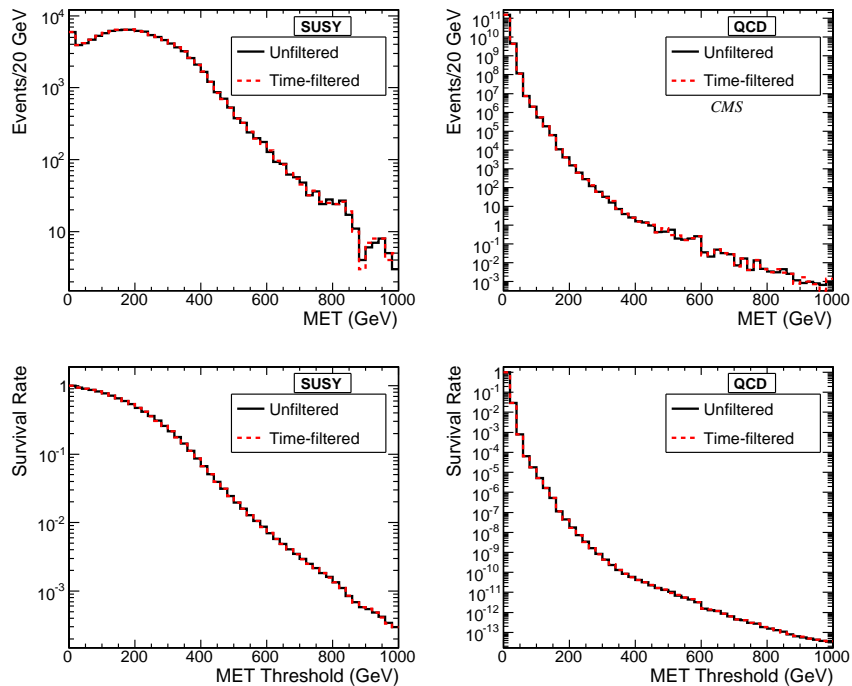

**Figure 11.** Time filter performance for SUSY and QCD processes showing the spectrum of filtered and unfiltered MET (top plots) and the MET survival rates (bottom plots). These indicate that the MET is not significantly affected by the operation of the time filter for in-time processes. These simulated samples were generated at  $\sqrt{s} = 10 \text{ TeV}$ ,  $L = 10^{30} \text{ cm}^{-2}\text{s}^{-1}$ , and with no pileup.

## 6 Summary

This paper has presented the technique used to determine the arrival time of energy deposits in the CMS HCAL to less than 25ns, and the use of this technique to suppress out-of-time backgrounds. The performance of the technique and of the synchronization system of the HCAL have been demonstrated using data from test beam operations as well as “beam splash” data from the LHC in September 2008. The ultimate resolution of the technique for hadron showers was measured to be 1.2 ns using test beam data, and the time spread of HCAL channels after hardware alignment in  $\eta$  was measured to be  $\pm 2$  ns, with an expected potential offline synchronization of less than 1 ns. Using data from CRAFT and beam operations in 2008, the use of a timing filter to suppress fake transverse missing energy was studied. This technique was effective in reducing the rate of MET produced by cosmic ray muons, detector noise, and beam background by a factor of 5–10. At the same time, the integrity of simulated signal MET distributions under the same filtering technique was verified. This technique and the timing results from HCAL in general are available for use in CMS analyses to suppress backgrounds or select particular signals.

## Acknowledgments

We thank the technical and administrative staff at CERN and other CMS Institutes, and acknowledge support from: FMSR (Austria); FNRS and FWO (Belgium); CNPq, CAPES, FAPERJ, and

FAPESP (Brazil); MES (Bulgaria); CERN; CAS, MoST, and NSFC (China); COLCIENCIAS (Colombia); MSES (Croatia); RPF (Cyprus); Academy of Sciences and NICPB (Estonia); Academy of Finland, ME, and HIP (Finland); CEA and CNRS/IN2P3 (France); BMBF, DFG, and HGF (Germany); GSRT (Greece); OTKA and NKTH (Hungary); DAE and DST (India); IPM (Iran); SFI (Ireland); INFN (Italy); NRF (Korea); LAS (Lithuania); CINVESTAV, CONACYT, SEP, and UASLP-FAI (Mexico); PAEC (Pakistan); SCSR (Poland); FCT (Portugal); JINR (Armenia, Belarus, Georgia, Ukraine, Uzbekistan); MST and MAE (Russia); MSTDS (Serbia); MICINN and CPAN (Spain); Swiss Funding Agencies (Switzerland); NSC (Taipei); TUBITAK and TAEK (Turkey); STFC (United Kingdom); DOE and NSF (USA). Individuals have received support from the Marie-Curie IEF program (European Union); the Leventis Foundation; the A. P. Sloan Foundation; and the Alexander von Humboldt Foundation.

## References

- [1] CMS collaboration, *The CMS experiment at the CERN LHC*, [2008 JINST 3 S08004](#).
- [2] L. Evans and P. Bryant eds., *LHC Machine*, [2008 JINST 3 S08001](#).
- [3] CMS collaboration, *Search for Heavy Stable Charged Particles*, [CMS-PAS-EXO-08-003](#) (2008).
- [4] CMS HCAL collaboration, *Design, performance and calibration of CMS hadron-barrel calorimeter wedges*, [Eur. Phys. J. C 55](#) (2008) 159.
- [5] CMS HCAL collaboration, *Design, performance and calibration of the CMS Hadron- outer calorimeter*, [Eur. Phys. J. C 57](#) (2008) 653.
- [6] T. Zimmerman and J. Hoff, *The Design of a Charge Integrating, Modified Floating Point ADC Chip*, [IEEE J. Solid State Circuits 39](#) (2004) 895.
- [7] CMS collaboration, *Performance of the CMS Level-1 trigger during commissioning with cosmic ray muons and LHC beams*, [2010 JINST 5 T03002](#).
- [8] USCMS collaboration, *The CMS barrel calorimeter response to particle beams from 2 GeV/c to 350 GeV/c*, [Eur. Phys. J. C 60](#) (2009) 359.
- [9] H. Pi et al., *Measurement of Missing Transverse Energy With the CMS Detector at the LHC*, [CMS-NOTE-2006-035](#) (2006).
- [10] CMS collaboration, *Commissioning of the CMS experiment and the cosmic run at four tesla*, [2010 JINST 5 T03001](#).
- [11] CMS collaboration, *Identification and filtering of uncharacteristic noise in the CMS hadron calorimeter*, [2010 JINST 5 T03014](#).
- [12] S.P. Martin, *A Supersymmetry Primer*, [hep-ph/9709356](#).
- [13] H. Baer, F.E. Paige, S.D. Protopopescu and X. Tata, *Simulating supersymmetry with ISAJET 7.0/ISASUSY 1.0*, [hep-ph/9305342](#).
- [14] T. Sjöstrand, S. Mrenna and P.Z. Skands, *PYTHIA 6.4 Physics and Manual*, [JHEP 05](#) (2006) 026 [[hep-ph/0603175](#)].
- [15] CMS collaboration, *CMS Physics Technical Design Report, Volume II: Physics Performance*, [J. Phys. G 34](#) (2007) 1387.

## The CMS collaboration

### Yerevan Physics Institute, Yerevan, Armenia

S. Chatrchyan, V. Khachatryan, A.M. Sirunyan

### Institut für Hochenergiephysik der OeAW, Wien, Austria

W. Adam, B. Arnold, H. Bergauer, T. Bergauer, M. Dragicevic, M. Eichberger, J. Erö, M. Friedl, R. Frühwirth, V.M. Ghete, J. Hammer<sup>1</sup>, S. Häsnel, M. Hoch, N. Hörmann, J. Hrubec, M. Jeitler, G. Kasieczka, K. Kastner, M. Krammer, D. Liko, I. Magrans de Abril, I. Mikulec, F. Mittermayr, B. Neuherz, M. Oberegger, M. Padrta, M. Pernicka, H. Rohringer, S. Schmid, R. Schöfbeck, T. Schreiner, R. Stark, H. Steininger, J. Strauss, A. Taurok, F. Teischinger, T. Themel, D. Uhl, P. Wagner, W. Waltenberger, G. Walzel, E. Widl, C.-E. Wulz

### National Centre for Particle and High Energy Physics, Minsk, Belarus

V. Chekhovsky, O. Dvornikov, I. Emeliantchik, A. Litomin, V. Makarenko, I. Marfin, V. Mossolov, N. Shumeiko, A. Solin, R. Stefanovitch, J. Suarez Gonzalez, A. Tikhonov

### Research Institute for Nuclear Problems, Minsk, Belarus

A. Fedorov, A. Karneyeu, M. Korzhik, V. Panov, R. Zuyevski

### Research Institute of Applied Physical Problems, Minsk, Belarus

P. Kuchinsky

### Universiteit Antwerpen, Antwerpen, Belgium

W. Beaumont, L. Benucci, M. Cardaci, E.A. De Wolf, E. Delmeire, D. Druzhkin, M. Hashemi, X. Janssen, T. Maes, L. Mucibello, S. Ochesanu, R. Rougny, M. Selvaggi, H. Van Haevermaet, P. Van Mechelen, N. Van Remortel

### Vrije Universiteit Brussel, Brussel, Belgium

V. Adler, S. Beauceron, S. Blyweert, J. D'Hondt, S. De Weirdt, O. Devroede, J. Heyninck, A. Kalogeropoulos, J. Maes, M. Maes, M.U. Mozer, S. Tavernier, W. Van Doninck<sup>1</sup>, P. Van Mulders, I. Vilella

### Université Libre de Bruxelles, Bruxelles, Belgium

O. Bouhali, E.C. Chabert, O. Charaf, B. Clerboux, G. De Lentdecker, V. Dero, S. Elgammal, A.P.R. Gay, G.H. Hammad, P.E. Marage, S. Rugovac, C. Vander Velde, P. Vanlaer, J. Wickens

### Ghent University, Ghent, Belgium

M. Grunewald, B. Klein, A. Marinov, D. Ryckbosch, F. Thyssen, M. Tytgat, L. Vanelderen, P. Verwilligen

### Université Catholique de Louvain, Louvain-la-Neuve, Belgium

S. Basegmez, G. Bruno, J. Caudron, C. Delaere, P. Demin, D. Favart, A. Giammanco, G. Grégoire, V. Lemaitre, O. Militaru, S. Ovyn, K. Piotrkowski<sup>1</sup>, L. Quertenmont, N. Schul

### Université de Mons, Mons, Belgium

N. Beliy, E. Daubie

### Centro Brasileiro de Pesquisas Fisicas, Rio de Janeiro, Brazil

G.A. Alves, M.E. Pol, M.H.G. Souza

**Universidade do Estado do Rio de Janeiro, Rio de Janeiro, Brazil**

W. Carvalho, D. De Jesus Damiao, C. De Oliveira Martins, S. Fonseca De Souza, L. Mundim, V. Oguri, A. Santoro, S.M. Silva Do Amaral, A. Sznajder

**Instituto de Fisica Teorica, Universidade Estadual Paulista, Sao Paulo, Brazil**

T.R. Fernandez Perez Tomei, M.A. Ferreira Dias, E. M. Gregores<sup>2</sup>, S.F. Novaes

**Institute for Nuclear Research and Nuclear Energy, Sofia, Bulgaria**

K. Abadjiev<sup>1</sup>, T. Anguelov, J. Damgov, N. Darmenov<sup>1</sup>, L. Dimitrov, V. Genchev<sup>1</sup>, P. Iaydjiev, S. Piperov, S. Stoykova, G. Sultanov, R. Trayanov, I. Vankov

**University of Sofia, Sofia, Bulgaria**

A. Dimitrov, M. Dyulendarova, V. Kozhuharov, L. Litov, E. Marinova, M. Mateev, B. Pavlov, P. Petkov, Z. Toteva<sup>1</sup>

**Institute of High Energy Physics, Beijing, China**

G.M. Chen, H.S. Chen, W. Guan, C.H. Jiang, D. Liang, B. Liu, X. Meng, J. Tao, J. Wang, Z. Wang, Z. Xue, Z. Zhang

**State Key Lab. of Nucl. Phys. and Tech., Peking University, Beijing, China**

Y. Ban, J. Cai, Y. Ge, S. Guo, Z. Hu, Y. Mao, S.J. Qian, H. Teng, B. Zhu

**Universidad de Los Andes, Bogota, Colombia**

C. Avila, M. Baquero Ruiz, C.A. Carrillo Montoya, A. Gomez, B. Gomez Moreno, A.A. Ocampo Rios, A.F. Osorio Oliveros, D. Reyes Romero, J.C. Sanabria

**Technical University of Split, Split, Croatia**

N. Godinovic, K. Lelas, R. Plestina, D. Polic, I. Puljak

**University of Split, Split, Croatia**

Z. Antunovic, M. Dzelalija

**Institute Rudjer Boskovic, Zagreb, Croatia**

V. Brigljevic, S. Duric, K. Kadija, S. Morovic

**University of Cyprus, Nicosia, Cyprus**

R. Fereos, M. Galanti, J. Mousa, A. Papadakis, F. Ptochos, P.A. Razis, D. Tsiakkouri, Z. Zinonos

**National Institute of Chemical Physics and Biophysics, Tallinn, Estonia**

A. Hektor, M. Kadastik, K. Kannike, M. Müntel, M. Raidal, L. Rebane

**Helsinki Institute of Physics, Helsinki, Finland**

E. Anttila, S. Czellar, J. Härkönen, A. Heikkinen, V. Karimäki, R. Kinnunen, J. Klem, M.J. Kortelainen, T. Lampén, K. Lassila-Perini, S. Lehti, T. Lindén, P. Luukka, T. Mäenpää, J. Nysten, E. Tuominen, J. Tuominiemi, D. Ungaro, L. Wendland

**Lappeenranta University of Technology, Lappeenranta, Finland**

K. Banzuzi, A. Korpela, T. Tuuva

**Laboratoire d'Annecy-le-Vieux de Physique des Particules, IN2P3-CNRS, Annecy-le-Vieux, France**

P. Nedelec, D. Sillou

**DSM/IRFU, CEA/Saclay, Gif-sur-Yvette, France**

M. Besancon, R. Chipaux, M. Dejardin, D. Denegri, J. Descamps, B. Fabbro, J.L. Faure, F. Ferri, S. Ganjour, F.X. Gentit, A. Givernaud, P. Gras, G. Hamel de Monchenault, P. Jarry, M.C. Lemaire, E. Locci, J. Malcles, M. Marionneau, L. Millischer, J. Rander, A. Rosowsky, D. Rousseau, M. Titov, P. Verrecchia

**Laboratoire Leprince-Ringuet, Ecole Polytechnique, IN2P3-CNRS, Palaiseau, France**

S. Baffioni, L. Bianchini, M. Bluj<sup>3</sup>, P. Busson, C. Charlot, L. Dobrzynski, R. Granier de Cassagnac, M. Haguenaer, P. Miné, P. Paganini, Y. Sirois, C. Thiebaux, A. Zabi

**Institut Pluridisciplinaire Hubert Curien, Université de Strasbourg, Université de Haute Alsace Mulhouse, CNRS/IN2P3, Strasbourg, France**

J.-L. Agram<sup>4</sup>, A. Besson, D. Bloch, D. Bodin, J.-M. Brom, E. Conte<sup>4</sup>, F. Drouhin<sup>4</sup>, J.-C. Fontaine<sup>4</sup>, D. Gelé, U. Goerlach, L. Gross, P. Juillot, A.-C. Le Bihan, Y. Patois, J. Speck, P. Van Hove

**Université de Lyon, Université Claude Bernard Lyon 1, CNRS-IN2P3, Institut de Physique Nucléaire de Lyon, Villeurbanne, France**

C. Baty, M. Bedjidian, J. Blaha, G. Boudoul, H. Brun, N. Chanon, R. Chierici, D. Contardo, P. Depasse, T. Dupasquier, H. El Mamouni, F. Fassi<sup>5</sup>, J. Fay, S. Gascon, B. Ille, T. Kurca, T. Le Grand, M. Lethuillier, N. Lumb, L. Mirabito, S. Perries, M. Vander Donckt, P. Verdier

**E. Andronikashvili Institute of Physics, Academy of Science, Tbilisi, Georgia**

N. Djaoshvili, N. Roinishvili, V. Roinishvili

**Institute of High Energy Physics and Informatization, Tbilisi State University, Tbilisi, Georgia**

N. Amaglobeli

**RWTH Aachen University, I. Physikalisches Institut, Aachen, Germany**

R. Adolphi, G. Anagnostou, R. Brauer, W. Braunschweig, M. Edelhoff, H. Esser, L. Feld, W. Karpinski, A. Khomich, K. Klein, N. Mohr, A. Ostapchouk, D. Pandoulas, G. Pierschel, F. Raupach, S. Schael, A. Schultz von Dratzig, G. Schwering, D. Sprenger, M. Thomas, M. Weber, B. Wittmer, M. Wlochal

**RWTH Aachen University, III. Physikalisches Institut A, Aachen, Germany**

O. Actis, G. Altenhöfer, W. Bender, P. Biallass, M. Erdmann, G. Fetchenhauer<sup>1</sup>, J. Frangenheim, T. Hebbeker, G. Hilgers, A. Hinzmann, K. Hoepfner, C. Hof, M. Kirsch, T. Klimkovich, P. Kreuzer<sup>1</sup>, D. Lanske<sup>†</sup>, M. Merschmeyer, A. Meyer, B. Philipps, H. Pieta, H. Reithler, S.A. Schmitz, L. Sonnenschein, M. Sowa, J. Steggemann, H. Szczesny, D. Teyssier, C. Zeidler

**RWTH Aachen University, III. Physikalisches Institut B, Aachen, Germany**

M. Bontenackels, M. Davids, M. Duda, G. Flügge, H. Geenen, M. Giffels, W. Haj Ahmad, T. Hermanns, D. Heydhausen, S. Kalinin, T. Kress, A. Linn, A. Nowack, L. Perchalla, M. Poettgens, O. Pooth, P. Sauerland, A. Stahl, D. Tornier, M.H. Zoeller

**Deutsches Elektronen-Synchrotron, Hamburg, Germany**

M. Aldaya Martin, U. Behrens, K. Borras, A. Campbell, E. Castro, D. Dammann, G. Eckerlin, A. Flossdorf, G. Flucke, A. Geiser, D. Hatton, J. Hauk, H. Jung, M. Kasemann, I. Katkov, C. Kleinwort, H. Kluge, A. Knutsson, E. Kuznetsova, W. Lange, W. Lohmann, R. Mankel<sup>1</sup>,

M. Marienfeld, A.B. Meyer, S. Miglioranza, J. Mnich, M. Ohlerich, J. Olzem, A. Parenti, C. Rosemann, R. Schmidt, T. Schoerner-Sadenius, D. Volyanskyy, C. Wissing, W.D. Zeuner<sup>1</sup>

**University of Hamburg, Hamburg, Germany**

C. Autermann, F. Bechtel, J. Draeger, D. Eckstein, U. Gebbert, K. Kaschube, G. Kaussen, R. Klanner, B. Mura, S. Naumann-Emme, F. Nowak, U. Pein, C. Sander, P. Schleper, T. Schum, H. Stadie, G. Steinbrück, J. Thomsen, R. Wolf

**Institut für Experimentelle Kernphysik, Karlsruhe, Germany**

J. Bauer, P. Blüm, V. Buege, A. Cakir, T. Chwalek, W. De Boer, A. Dierlamm, G. Dirkes, M. Feindt, U. Felzmann, M. Frey, A. Furgeri, J. Gruschke, C. Hackstein, F. Hartmann<sup>1</sup>, S. Heier, M. Heinrich, H. Held, D. Hirschebuehl, K.H. Hoffmann, S. Honc, C. Jung, T. Kuhr, T. Liamsuwan, D. Martschei, S. Mueller, Th. Müller, M.B. Neuland, M. Niegel, O. Oberst, A. Oehler, J. Ott, T. Peiffer, D. Piparo, G. Quast, K. Rabbertz, F. Ratnikov, N. Ratnikova, M. Renz, C. Saout<sup>1</sup>, G. Sartisoehn, A. Scheurer, P. Schieferdecker, F.-P. Schilling, G. Schott, H.J. Simonis, F.M. Stober, P. Sturm, D. Troendle, A. Trunov, W. Wagner, J. Wagner-Kuhr, M. Zeise, V. Zhukov<sup>6</sup>, E.B. Ziebarth

**Institute of Nuclear Physics "Demokritos", Aghia Paraskevi, Greece**

G. Daskalakis, T. Geralis, K. Karafasoulis, A. Kyriakis, D. Loukas, A. Markou, C. Markou, C. Mavrommatis, E. Petrakou, A. Zachariadou

**University of Athens, Athens, Greece**

L. Gouskos, P. Katsas, A. Panagiotou<sup>1</sup>

**University of Ioánnina, Ioánnina, Greece**

I. Evangelou, P. Kokkas, N. Manthos, I. Papadopoulos, V. Patras, F.A. Triantis

**KFKI Research Institute for Particle and Nuclear Physics, Budapest, Hungary**

G. Bencze<sup>1</sup>, L. Boldizsar, G. Debreczeni, C. Hajdu<sup>1</sup>, S. Hernath, P. Hidas, D. Horvath<sup>7</sup>, K. Krajczar, A. Laszlo, G. Patay, F. Sikler, N. Toth, G. Vesztergombi

**Institute of Nuclear Research ATOMKI, Debrecen, Hungary**

N. Beni, G. Christian, J. Imrek, J. Molnar, D. Novak, J. Palinkas, G. Szekely, Z. Szillasi<sup>1</sup>, K. Tokesi, V. Veszpremi

**University of Debrecen, Debrecen, Hungary**

A. Kapusi, G. Marian, P. Raics, Z. Szabo, Z.L. Trocsanyi, B. Ujvari, G. Zilizi

**Panjab University, Chandigarh, India**

S. Bansal, H.S. Bawa, S.B. Beri, V. Bhatnagar, M. Jindal, M. Kaur, R. Kaur, J.M. Kohli, M.Z. Mehta, N. Nishu, L.K. Saini, A. Sharma, A. Singh, J.B. Singh, S.P. Singh

**University of Delhi, Delhi, India**

S. Ahuja, S. Arora, S. Bhattacharya<sup>8</sup>, S. Chauhan, B.C. Choudhary, P. Gupta, S. Jain, S. Jain, M. Jha, A. Kumar, K. Ranjan, R.K. Shivpuri, A.K. Srivastava

**Bhabha Atomic Research Centre, Mumbai, India**

R.K. Choudhury, D. Dutta, S. Kailas, S.K. Kataria, A.K. Mohanty, L.M. Pant, P. Shukla, A. Topkar

**Tata Institute of Fundamental Research - EHEP, Mumbai, India**

T. Aziz, M. Guchait<sup>9</sup>, A. Gurtu, M. Maity<sup>10</sup>, D. Majumder, G. Majumder, K. Mazumdar, A. Nayak, A. Saha, K. Sudhakar

**Tata Institute of Fundamental Research - HECR, Mumbai, India**

S. Banerjee, S. Dugad, N.K. Mondal

**Institute for Studies in Theoretical Physics & Mathematics (IPM), Tehran, Iran**

H. Arfaei, H. Bakhshiansohi, A. Fahim, A. Jafari, M. Mohammadi Najafabadi, A. Moshaii, S. Paktinat Mehdiabadi, S. Rouhani, B. Safarzadeh, M. Zeinali

**University College Dublin, Dublin, Ireland**

M. Felcini

**INFN Sezione di Bari <sup>a</sup>, Università di Bari <sup>b</sup>, Politecnico di Bari <sup>c</sup>, Bari, Italy**

M. Abbrescia<sup>a,b</sup>, L. Barbone<sup>a</sup>, F. Chiumarulo<sup>a</sup>, A. Clemente<sup>a</sup>, A. Colaleo<sup>a</sup>, D. Creanza<sup>a,c</sup>, G. Cuscela<sup>a</sup>, N. De Filippis<sup>a</sup>, M. De Palma<sup>a,b</sup>, G. De Robertis<sup>a</sup>, G. Donvito<sup>a</sup>, F. Fedele<sup>a</sup>, L. Fiore<sup>a</sup>, M. Franco<sup>a</sup>, G. Iaselli<sup>a,c</sup>, N. Lacalamita<sup>a</sup>, F. Loddo<sup>a</sup>, L. Lusito<sup>a,b</sup>, G. Maggi<sup>a,c</sup>, M. Maggi<sup>a</sup>, N. Manna<sup>a,b</sup>, B. Marangelli<sup>a,b</sup>, S. My<sup>a,c</sup>, S. Natali<sup>a,b</sup>, S. Nuzzo<sup>a,b</sup>, G. Papagni<sup>a</sup>, S. Piccolomo<sup>a</sup>, G.A. Pierro<sup>a</sup>, C. Pinto<sup>a</sup>, A. Pompili<sup>a,b</sup>, G. Pugliese<sup>a,c</sup>, R. Rajan<sup>a</sup>, A. Ranieri<sup>a</sup>, F. Romano<sup>a,c</sup>, G. Roselli<sup>a,b</sup>, G. Selvaggi<sup>a,b</sup>, Y. Shinde<sup>a</sup>, L. Silvestris<sup>a</sup>, S. Tuppiti<sup>a,b</sup>, G. Zito<sup>a</sup>

**INFN Sezione di Bologna <sup>a</sup>, Università di Bologna <sup>b</sup>, Bologna, Italy**

G. Abbiendi<sup>a</sup>, W. Bacchi<sup>a,b</sup>, A.C. Benvenuti<sup>a</sup>, M. Boldini<sup>a</sup>, D. Bonacorsi<sup>a</sup>, S. Braibant-Giacomelli<sup>a,b</sup>, V.D. Cafaro<sup>a</sup>, S.S. Caiazza<sup>a</sup>, P. Capiluppi<sup>a,b</sup>, A. Castro<sup>a,b</sup>, F.R. Cavallo<sup>a</sup>, G. Codispoti<sup>a,b</sup>, M. Cuffiani<sup>a,b</sup>, I. D'Antone<sup>a</sup>, G.M. Dallavalle<sup>a,1</sup>, F. Fabbri<sup>a</sup>, A. Fanfani<sup>a,b</sup>, D. Fasanella<sup>a</sup>, P. Giacomelli<sup>a</sup>, V. Giordano<sup>a</sup>, M. Giunta<sup>a,1</sup>, C. Grandi<sup>a</sup>, M. Guerzoni<sup>a</sup>, S. Marcellini<sup>a</sup>, G. Masetti<sup>a,b</sup>, A. Montanari<sup>a</sup>, F.L. Navarria<sup>a,b</sup>, F. Odorici<sup>a</sup>, G. Pellegrini<sup>a</sup>, A. Perrotta<sup>a</sup>, A.M. Rossi<sup>a,b</sup>, T. Rovelli<sup>a,b</sup>, G. Siroli<sup>a,b</sup>, G. Torromeo<sup>a</sup>, R. Travaglini<sup>a,b</sup>

**INFN Sezione di Catania <sup>a</sup>, Università di Catania <sup>b</sup>, Catania, Italy**

S. Albergo<sup>a,b</sup>, S. Costa<sup>a,b</sup>, R. Potenza<sup>a,b</sup>, A. Tricomi<sup>a,b</sup>, C. Tuve<sup>a</sup>

**INFN Sezione di Firenze <sup>a</sup>, Università di Firenze <sup>b</sup>, Firenze, Italy**

G. Barbagli<sup>a</sup>, G. Broccolo<sup>a,b</sup>, V. Ciulli<sup>a,b</sup>, C. Civinini<sup>a</sup>, R. D'Alessandro<sup>a,b</sup>, E. Focardi<sup>a,b</sup>, S. Frosali<sup>a,b</sup>, E. Gallo<sup>a</sup>, C. Genta<sup>a,b</sup>, G. Landi<sup>a,b</sup>, P. Lenzi<sup>a,b,1</sup>, M. Meschini<sup>a</sup>, S. Paoletti<sup>a</sup>, G. Sguazzoni<sup>a</sup>, A. Tropiano<sup>a</sup>

**INFN Laboratori Nazionali di Frascati, Frascati, Italy**

L. Benussi, M. Bertani, S. Bianco, S. Colafranceschi<sup>11</sup>, D. Colonna<sup>11</sup>, F. Fabbri, M. Giardoni, L. Passamonti, D. Piccolo, D. Pierluigi, B. Ponzio, A. Russo

**INFN Sezione di Genova, Genova, Italy**

P. Fabbricatore, R. Musenich

**INFN Sezione di Milano-Bicocca <sup>a</sup>, Università di Milano-Bicocca <sup>b</sup>, Milano, Italy**

A. Benaglia<sup>a</sup>, M. Calloni<sup>a</sup>, G.B. Cerati<sup>a,b,1</sup>, P. D'Angelo<sup>a</sup>, F. De Guio<sup>a</sup>, F.M. Farina<sup>a</sup>, A. Ghezzi<sup>a</sup>, P. Govoni<sup>a,b</sup>, M. Malberti<sup>a,b,1</sup>, S. Malvezzi<sup>a</sup>, A. Martelli<sup>a</sup>, D. Menasce<sup>a</sup>, V. Miccio<sup>a,b</sup>, L. Moroni<sup>a</sup>, P. Negri<sup>a,b</sup>, M. Paganoni<sup>a,b</sup>, D. Pedrini<sup>a</sup>, A. Pullia<sup>a,b</sup>, S. Ragazzi<sup>a,b</sup>, N. Redaelli<sup>a</sup>, S. Sala<sup>a</sup>, R. Salerno<sup>a,b</sup>, T. Tabarelli de Fatis<sup>a,b</sup>, V. Tancini<sup>a,b</sup>, S. Taroni<sup>a,b</sup>

**INFN Sezione di Napoli <sup>a</sup>, Università di Napoli "Federico II" <sup>b</sup>, Napoli, Italy**

S. Buontempo<sup>a</sup>, N. Cavallo<sup>a</sup>, A. Cimmino<sup>a,b,1</sup>, M. De Gruttola<sup>a,b,1</sup>, F. Fabozzi<sup>a,12</sup>, A.O.M. Iorio<sup>a</sup>, L. Lista<sup>a</sup>, D. Lomidze<sup>a</sup>, P. Noli<sup>a,b</sup>, P. Paolucci<sup>a</sup>, C. Sciacca<sup>a,b</sup>

2010 JINST 5 T03013

**INFN Sezione di Padova <sup>a</sup>, Università di Padova <sup>b</sup>, Padova, Italy**

P. Azzi<sup>a,1</sup>, N. Bacchetta<sup>a</sup>, L. Barcellan<sup>a</sup>, P. Bellan<sup>a,b,1</sup>, M. Bellato<sup>a</sup>, M. Benettoni<sup>a</sup>, M. Biasotto<sup>a,13</sup>, D. Bisello<sup>a,b</sup>, E. Borsato<sup>a,b</sup>, A. Branca<sup>a</sup>, R. Carlin<sup>a,b</sup>, L. Castellani<sup>a</sup>, P. Checchia<sup>a</sup>, E. Conti<sup>a</sup>, F. Dal Corso<sup>a</sup>, M. De Mattia<sup>a,b</sup>, T. Dorigo<sup>a</sup>, U. Dosselli<sup>a</sup>, F. Fanzago<sup>a</sup>, F. Gasparini<sup>a,b</sup>, U. Gasparini<sup>a,b</sup>, P. Giubilato<sup>a,b</sup>, F. Gonella<sup>a</sup>, A. Gresele<sup>a,14</sup>, M. Gulmini<sup>a,13</sup>, A. Kaminskiy<sup>a,b</sup>, S. Lacaprara<sup>a,13</sup>, I. Lazzizzera<sup>a,14</sup>, M. Margoni<sup>a,b</sup>, G. Maron<sup>a,13</sup>, S. Mattiazzo<sup>a,b</sup>, M. Mazzucato<sup>a</sup>, M. Meneghelli<sup>a</sup>, A.T. Meneguzzo<sup>a,b</sup>, M. Michelotto<sup>a</sup>, F. Montecassiano<sup>a</sup>, M. Nespolo<sup>a</sup>, M. Passaseo<sup>a</sup>, M. Pegoraro<sup>a</sup>, L. Perrozzi<sup>a</sup>, N. Pozzobon<sup>a,b</sup>, P. Ronchese<sup>a,b</sup>, F. Simonetto<sup>a,b</sup>, N. Toniolo<sup>a</sup>, E. Torassa<sup>a</sup>, M. Tosi<sup>a,b</sup>, A. Triossi<sup>a</sup>, S. Vanini<sup>a,b</sup>, S. Ventura<sup>a</sup>, P. Zotto<sup>a,b</sup>, G. Zumerle<sup>a,b</sup>

**INFN Sezione di Pavia <sup>a</sup>, Università di Pavia <sup>b</sup>, Pavia, Italy**

P. Baesso<sup>a,b</sup>, U. Berzano<sup>a</sup>, S. Bricola<sup>a</sup>, M.M. Necchi<sup>a,b</sup>, D. Pagano<sup>a,b</sup>, S.P. Ratti<sup>a,b</sup>, C. Riccardi<sup>a,b</sup>, P. Torre<sup>a,b</sup>, A. Vicini<sup>a</sup>, P. Vitulo<sup>a,b</sup>, C. Viviani<sup>a,b</sup>

**INFN Sezione di Perugia <sup>a</sup>, Università di Perugia <sup>b</sup>, Perugia, Italy**

D. Aisa<sup>a</sup>, S. Aisa<sup>a</sup>, E. Babucci<sup>a</sup>, M. Biasini<sup>a,b</sup>, G.M. Bilei<sup>a</sup>, B. Caponeri<sup>a,b</sup>, B. Checcucci<sup>a</sup>, N. Dinu<sup>a</sup>, L. Fanò<sup>a</sup>, L. Farnesini<sup>a</sup>, P. Lariccia<sup>a,b</sup>, A. Lucaroni<sup>a,b</sup>, G. Mantovani<sup>a,b</sup>, A. Nappi<sup>a,b</sup>, A. Piluso<sup>a</sup>, V. Postolache<sup>a</sup>, A. Santocchia<sup>a,b</sup>, L. Servoli<sup>a</sup>, D. Tonoiu<sup>a</sup>, A. Vedae<sup>a</sup>, R. Volpe<sup>a,b</sup>

**INFN Sezione di Pisa <sup>a</sup>, Università di Pisa <sup>b</sup>, Scuola Normale Superiore di Pisa <sup>c</sup>, Pisa, Italy**

P. Azzurri<sup>a,c</sup>, G. Bagliesi<sup>a</sup>, J. Bernardini<sup>a,b</sup>, L. Berretta<sup>a</sup>, T. Boccali<sup>a</sup>, A. Bocci<sup>a,c</sup>, L. Borrello<sup>a,c</sup>, F. Bosi<sup>a</sup>, F. Calzolari<sup>a</sup>, R. Castaldi<sup>a</sup>, R. Dell'Orso<sup>a</sup>, F. Fiori<sup>a,b</sup>, L. Foà<sup>a,c</sup>, S. Gennai<sup>a,c</sup>, A. Giassi<sup>a</sup>, A. Kraan<sup>a</sup>, F. Ligabue<sup>a,c</sup>, T. Lomtadze<sup>a</sup>, F. Mariani<sup>a</sup>, L. Martini<sup>a</sup>, M. Massa<sup>a</sup>, A. Messineo<sup>a,b</sup>, A. Moggi<sup>a</sup>, F. Palla<sup>a</sup>, F. Palmonari<sup>a</sup>, G. Petraghani<sup>a</sup>, G. Petrucciani<sup>a,c</sup>, F. Raffaelli<sup>a</sup>, S. Sarkar<sup>a</sup>, G. Segneri<sup>a</sup>, A.T. Serban<sup>a</sup>, P. Spagnolo<sup>a,1</sup>, R. Tenchini<sup>a,1</sup>, S. Tolaini<sup>a</sup>, G. Tonelli<sup>a,b,1</sup>, A. Venturi<sup>a</sup>, P.G. Verdini<sup>a</sup>

**INFN Sezione di Roma <sup>a</sup>, Università di Roma "La Sapienza" <sup>b</sup>, Roma, Italy**

S. Baccaro<sup>a,15</sup>, L. Barone<sup>a,b</sup>, A. Bartoloni<sup>a</sup>, F. Cavallari<sup>a,1</sup>, I. Dafinei<sup>a</sup>, D. Del Re<sup>a,b</sup>, E. Di Marco<sup>a,b</sup>, M. Diemoz<sup>a</sup>, D. Franci<sup>a,b</sup>, E. Longo<sup>a,b</sup>, G. Organtini<sup>a,b</sup>, A. Palma<sup>a,b</sup>, F. Pandolfi<sup>a,b</sup>, R. Paramatti<sup>a,1</sup>, F. Pellegrino<sup>a</sup>, S. Rahatlou<sup>a,b</sup>, C. Rovelli<sup>a</sup>

**INFN Sezione di Torino <sup>a</sup>, Università di Torino <sup>b</sup>, Università del Piemonte Orientale (Novara) <sup>c</sup>, Torino, Italy**

G. Alampi<sup>a</sup>, N. Amapane<sup>a,b</sup>, R. Arcidiacono<sup>a,b</sup>, S. Argiro<sup>a,b</sup>, M. Arneodo<sup>a,c</sup>, C. Biino<sup>a</sup>, M.A. Borgia<sup>a,b</sup>, C. Botta<sup>a,b</sup>, N. Cartiglia<sup>a</sup>, R. Castello<sup>a,b</sup>, G. Cerminara<sup>a,b</sup>, M. Costa<sup>a,b</sup>, D. Dattola<sup>a</sup>, G. Dellacasa<sup>a</sup>, N. Demaria<sup>a</sup>, G. Dughera<sup>a</sup>, F. Dumitrache<sup>a</sup>, A. Graziano<sup>a,b</sup>, C. Mariotti<sup>a</sup>, M. Marone<sup>a,b</sup>, S. Maselli<sup>a</sup>, E. Migliore<sup>a,b</sup>, G. Mila<sup>a,b</sup>, V. Monaco<sup>a,b</sup>, M. Musich<sup>a,b</sup>, M. Nervo<sup>a,b</sup>, M.M. Obertino<sup>a,c</sup>, S. Oggero<sup>a,b</sup>, R. Panero<sup>a</sup>, N. Pastrone<sup>a</sup>, M. Pelliccioni<sup>a,b</sup>, A. Romero<sup>a,b</sup>, M. Ruspa<sup>a,c</sup>, R. Sacchi<sup>a,b</sup>, A. Solano<sup>a,b</sup>, A. Staiano<sup>a</sup>, P.P. Trapani<sup>a,b,1</sup>, D. Trocino<sup>a,b</sup>, A. Vilela Pereira<sup>a,b</sup>, L. Visca<sup>a,b</sup>, A. Zampieri<sup>a</sup>

**INFN Sezione di Trieste <sup>a</sup>, Università di Trieste <sup>b</sup>, Trieste, Italy**

F. Ambroglini<sup>a,b</sup>, S. Belforte<sup>a</sup>, F. Cossutti<sup>a</sup>, G. Della Ricca<sup>a,b</sup>, B. Gobbo<sup>a</sup>, A. Penzo<sup>a</sup>

**Kyungpook National University, Daegu, Korea**

S. Chang, J. Chung, D.H. Kim, G.N. Kim, D.J. Kong, H. Park, D.C. Son

**Wonkwang University, Iksan, Korea**

S.Y. Bahk

**Chonnam National University, Kwangju, Korea**

S. Song

**Konkuk University, Seoul, Korea**

S.Y. Jung

**Korea University, Seoul, Korea**

B. Hong, H. Kim, J.H. Kim, K.S. Lee, D.H. Moon, S.K. Park, H.B. Rhee, K.S. Sim

**Seoul National University, Seoul, Korea**

J. Kim

**University of Seoul, Seoul, Korea**

M. Choi, G. Hahn, I.C. Park

**Sungkyunkwan University, Suwon, Korea**

S. Choi, Y. Choi, J. Goh, H. Jeong, T.J. Kim, J. Lee, S. Lee

**Vilnius University, Vilnius, Lithuania**

M. Janulis, D. Martisiute, P. Petrov, T. Sabonis

**Centro de Investigacion y de Estudios Avanzados del IPN, Mexico City, Mexico**H. Castilla Valdez<sup>1</sup>, A. Sánchez Hernández**Universidad Iberoamericana, Mexico City, Mexico**

S. Carrillo Moreno

**Universidad Autónoma de San Luis Potosí, San Luis Potosí, Mexico**

A. Morelos Pineda

**University of Auckland, Auckland, New Zealand**

P. Allfrey, R.N.C. Gray, D. Krofcheck

**University of Canterbury, Christchurch, New Zealand**

N. Bernardino Rodrigues, P.H. Butler, T. Signal, J.C. Williams

**National Centre for Physics, Quaid-I-Azam University, Islamabad, Pakistan**

M. Ahmad, I. Ahmed, W. Ahmed, M.I. Asghar, M.I.M. Awan, H.R. Hoorani, I. Hussain, W.A. Khan, T. Khurshid, S. Muhammad, S. Qazi, H. Shahzad

**Institute of Experimental Physics, Warsaw, Poland**M. Cwiok, R. Dabrowski, W. Dominik, K. Doroba, M. Konecki, J. Krolikowski, K. Pozniak<sup>16</sup>, R. Romaniuk, W. Zabolotny<sup>16</sup>, P. Zych**Soltan Institute for Nuclear Studies, Warsaw, Poland**

T. Frueboes, R. Gokieli, L. Gosciolo, M. Górski, M. Kazana, K. Nawrocki, M. Szleper, G. Wrochna, P. Zalewski

**Laboratório de Instrumentação e Física Experimental de Partículas, Lisboa, Portugal**

N. Almeida, L. Antunes Pedro, P. Bargassa, A. David, P. Faccioli, P.G. Ferreira Parracho, M. Freitas Ferreira, M. Gallinaro, M. Guerra Jordao, P. Martins, G. Mini, P. Musella, J. Pela, L. Raposo, P.Q. Ribeiro, S. Sampaio, J. Seixas, J. Silva, P. Silva, D. Soares, M. Sousa, J. Varela, H.K. Wöhri

**Joint Institute for Nuclear Research, Dubna, Russia**

I. Altsybeev, I. Belotelov, P. Bunin, Y. Ershov, I. Filozova, M. Finger, M. Finger Jr., A. Golunov, I. Golutvin, N. Gorbounov, V. Kalagin, A. Kamenev, V. Karjavin, V. Konoplyanikov, V. Korenkov, G. Kozlov, A. Kurenkov, A. Lanev, A. Makankin, V.V. Mitsyn, P. Moisezenz, E. Nikonov, D. Oleynik, V. Palichik, V. Perelygin, A. Petrosyan, R. Semenov, S. Shmatov, V. Smirnov, D. Smolin, E. Tikhonenko, S. Vasil'ev, A. Vishnevskiy, A. Volodko, A. Zarubin, V. Zhiltsov

**Petersburg Nuclear Physics Institute, Gatchina (St Petersburg), Russia**

N. Bondar, L. Chtchipounov, A. Denisov, Y. Gavrikov, G. Gavrillov, V. Golovtsov, Y. Ivanov, V. Kim, V. Kozlov, P. Levchenko, G. Obrant, E. Orishchin, A. Petrunin, Y. Shcheglov, A. Shchetkovskiy, V. Sknar, I. Smirnov, V. Sulimov, V. Tarakanov, L. Uvarov, S. Vavilov, G. Velichko, S. Volkov, A. Vorobyev

**Institute for Nuclear Research, Moscow, Russia**

Yu. Andreev, A. Anisimov, P. Antipov, A. Dermenev, S. Gninenko, N. Golubev, M. Kirsanov, N. Krasnikov, V. Matveev, A. Pashenkov, V.E. Postoev, A. Solovey, A. Solovey, A. Toropin, S. Troitsky

**Institute for Theoretical and Experimental Physics, Moscow, Russia**

A. Baud, V. Epshteyn, V. Gavrillov, N. Ilina, V. Kaftanov<sup>†</sup>, V. Kolosov, M. Kossov<sup>1</sup>, A. Krokhotin, S. Kuleshov, A. Oulianov, G. Safronov, S. Semenov, I. Shreyber, V. Stolin, E. Vlasov, A. Zhokin

**Moscow State University, Moscow, Russia**

E. Boos, M. Dubinin<sup>17</sup>, L. Dudko, A. Ershov, A. Gribushin, V. Klyukhin, O. Kodolova, I. Lokhtin, S. Petrushanko, L. Sarycheva, V. Savrin, A. Snigirev, I. Vardanyan

**P.N. Lebedev Physical Institute, Moscow, Russia**

I. Dremin, M. Kirakosyan, N. Konovalova, S.V. Rusakov, A. Vinogradov

**State Research Center of Russian Federation, Institute for High Energy Physics, Protvino, Russia**

S. Akimenko, A. Artamonov, I. Azhgirey, S. Bitioukov, V. Burtovoy, V. Grishin<sup>1</sup>, V. Kachanov, D. Konstantinov, V. Krychkin, A. Levine, I. Lobov, V. Lukanin, Y. Mel'nik, V. Petrov, R. Ryutin, S. Slabospitsky, A. Sobol, A. Sytine, L. Tourtchanovitch, S. Troshin, N. Tyurin, A. Uzunian, A. Volkov

**Vinca Institute of Nuclear Sciences, Belgrade, Serbia**

P. Adzic, M. Djordjevic, D. Jovanovic<sup>18</sup>, D. Krpic<sup>18</sup>, D. Maletic, J. Puzovic<sup>18</sup>, N. Smiljkovic

**Centro de Investigaciones Energéticas Medioambientales y Tecnológicas (CIEMAT), Madrid, Spain**

M. Aguilar-Benitez, J. Alberdi, J. Alcaraz Maestre, P. Arce, J.M. Barcala, C. Battilana, C. Burgos Lazaro, J. Caballero Bejar, E. Calvo, M. Cardenas Montes, M. Cepeda, M. Cerrada, M. Chamizo Llatas, F. Clemente, N. Colino, M. Daniel, B. De La Cruz, A. Delgado Peris, C. Diez Pardos, C. Fernandez Bedoya, J.P. Fernández Ramos, A. Ferrando, J. Flix, M.C. Fouz, P. Garcia-Abia, A.C. Garcia-Bonilla, O. Gonzalez Lopez, S. Goy Lopez, J.M. Hernandez, M.I. Josa, J. Marin, G. Merino, J. Molina, A. Molinero, J.J. Navarrete, J.C. Oller, J. Puerta Pelayo, L. Romero, J. Santaolalla, C. Villanueva Munoz, C. Willmott, C. Yuste

**Universidad Autónoma de Madrid, Madrid, Spain**

C. Albajar, M. Blanco Otano, J.F. de Trocóniz, A. García Raboso, J.O. Lopez Berengueres

**Universidad de Oviedo, Oviedo, Spain**

J. Cuevas, J. Fernandez Menendez, I. Gonzalez Caballero, L. Lloret Iglesias, H. Naves Sordo, J.M. Vizan Garcia

**Instituto de Física de Cantabria (IFCA), CSIC-Universidad de Cantabria, Santander, Spain**

I.J. Cabrillo, A. Calderon, S.H. Chuang, I. Diaz Merino, C. Diez Gonzalez, J. Duarte Campderros, M. Fernandez, G. Gomez, J. Gonzalez Sanchez, R. Gonzalez Suarez, C. Jorda, P. Lobelle Pardo, A. Lopez Virto, J. Marco, R. Marco, C. Martinez Rivero, P. Martinez Ruiz del Arbol, F. Matorras, T. Rodrigo, A. Ruiz Jimeno, L. Scodellaro, M. Sobron Sanudo, I. Vila, R. Vilar Cortabitarte

**CERN, European Organization for Nuclear Research, Geneva, Switzerland**

D. Abbaneo, E. Albert, M. Alidra, S. Ashby, E. Auffray, J. Baechler, P. Baillon, A.H. Ball, S.L. Bally, D. Barney, F. Beaudette<sup>19</sup>, R. Bellan, D. Benedetti, G. Benelli, C. Bernet, P. Bloch, S. Bolognesi, M. Bona, J. Bos, N. Bourgeois, T. Bourrel, H. Breuker, K. Bunkowski, D. Campi, T. Camporesi, E. Cano, A. Cattai, J.P. Chatelain, M. Chauvey, T. Christiansen, J.A. Coarasa Perez, A. Conde Garcia, R. Covarelli, B. Curé, A. De Roeck, V. Delachenal, D. Deyrail, S. Di Vincenzo<sup>20</sup>, S. Dos Santos, T. Dupont, L.M. Edera, A. Elliott-Peisert, M. Eppard, M. Favre, N. Frank, W. Funk, A. Gaddi, M. Gastal, M. Gateau, H. Gerwig, D. Gigi, K. Gill, D. Giordano, J.P. Girod, F. Glege, R. Gomez-Reino Garrido, R. Goudard, S. Gowdy, R. Guida, L. Guiducci, J. Gutleber, M. Hansen, C. Hartl, J. Harvey, B. Hegner, H.F. Hoffmann, A. Holzner, A. Honma, M. Huhtinen, V. Innocente, P. Janot, G. Le Godec, P. Lecoq, C. Leonidopoulos, R. Loos, C. Lourenço, A. Lyonnet, A. Macpherson, N. Magini, J.D. Maillefaud, G. Maire, T. Mäki, L. Malgeri, M. Mannelli, L. Masetti, F. Meijers, P. Meridiani, S. Mersi, E. Meschi, A. Meynet Cordonnier, R. Moser, M. Mulders, J. Mulon, M. Noy, A. Oh, G. Olesen, A. Onnela, T. Orimoto, L. Orsini, E. Perez, G. Perinic, J.F. Pernot, P. Petagna, P. Petiot, A. Petrilli, A. Pfeiffer, M. Pierini, M. Pimiä, R. Pintus, B. Pirolet, H. Postema, A. Racz, S. Ravat, S.B. Rew, J. Rodrigues Antunes, G. Rolandi<sup>21</sup>, M. Rovere, V. Ryjov, H. Sakulin, D. Samyn, H. Sauce, C. Schäfer, W.D. Schlatter, M. Schröder, C. Schwick, A. Sciaba, I. Segoni, A. Sharma, N. Siegrist, P. Siegrist, N. Sinanis, T. Sobrier, P. Sphicas<sup>22</sup>, D. Spiga, M. Spiropulu<sup>17</sup>, F. Stöckli, P. Traczyk, P. Tropea, J. Troska, A. Tsirou, L. Veillet, G.I. Veres, M. Voutilainen, P. Wertelaers, M. Zanetti

**Paul Scherrer Institut, Villigen, Switzerland**

W. Bertl, K. Deiters, W. Erdmann, K. Gabathuler, R. Horisberger, Q. Ingram, H.C. Kaestli, S. König, D. Kotlinski, U. Langenegger, F. Meier, D. Renker, T. Rohe, J. Sibille<sup>23</sup>, A. Starodumov<sup>24</sup>

**Institute for Particle Physics, ETH Zurich, Zurich, Switzerland**

B. Betev, L. Caminada<sup>25</sup>, Z. Chen, S. Cittolin, D.R. Da Silva Di Calafiori, S. Dambach<sup>25</sup>, G. Dissertori, M. Dittmar, C. Eggel<sup>25</sup>, J. Eugster, G. Faber, K. Freudenreich, C. Grab, A. Hervé, W. Hintz, P. Lecomte, P.D. Luckey, W. Lustermann, C. Marchica<sup>25</sup>, P. Milenovic<sup>26</sup>, F. Moortgat, A. Nardulli, F. Nessi-Tedaldi, L. Pape, F. Pauss, T. Punz, A. Rizzi, F.J. Ronga, L. Sala, A.K. Sanchez, M.-C. Sawley, V. Sordini, B. Stieger, L. Tauscher<sup>†</sup>, A. Thea, K. Theofilatos, D. Treille, P. Trüb<sup>25</sup>, M. Weber, L. Wehrli, J. Weng, S. Zelepoukine<sup>27</sup>

**Universität Zürich, Zurich, Switzerland**

C. Amsler, V. Chiochia, S. De Visscher, C. Regenfus, P. Robmann, T. Rommelskirchen, A. Schmidt, D. Tsirigkas, L. Wilke

**National Central University, Chung-Li, Taiwan**

Y.H. Chang, E.A. Chen, W.T. Chen, A. Go, C.M. Kuo, S.W. Li, W. Lin

**National Taiwan University (NTU), Taipei, Taiwan**

P. Bartalini, P. Chang, Y. Chao, K.F. Chen, W.-S. Hou, Y. Hsiung, Y.J. Lei, S.W. Lin, R.-S. Lu, J. Schümann, J.G. Shiu, Y.M. Tzeng, K. Ueno, Y. Velikzhanin, C.C. Wang, M. Wang

**Cukurova University, Adana, Turkey**

A. Adiguzel, A. Ayhan, A. Azman Gokce, M.N. Bakirci, S. Cerci, I. Dumanoglu, E. Eskut, S. Girgis, E. Gurpinar, I. Hos, T. Karaman, T. Karaman, A. Kayis Topaksu, P. Kurt, G. Önengüt, G. Önengüt Gökbulut, K. Ozdemir, S. Ozturk, A. Polatöz, K. Sogut<sup>28</sup>, B. Tali, H. Topakli, D. Uzun, L.N. Vergili, M. Vergili

**Middle East Technical University, Physics Department, Ankara, Turkey**

I.V. Akin, T. Aliev, S. Bilmis, M. Deniz, H. Gamsizkan, A.M. Guler, K. Öcalan, M. Serin, R. Sever, U.E. Surat, M. Zeyrek

**Bogaçiçi University, Department of Physics, Istanbul, Turkey**

M. Deliomeroglu, D. Demir<sup>29</sup>, E. Gülmez, A. Halu, B. Isildak, M. Kaya<sup>30</sup>, O. Kaya<sup>30</sup>, S. Ozkorucuklu<sup>31</sup>, N. Sonmez<sup>32</sup>

**National Scientific Center, Kharkov Institute of Physics and Technology, Kharkov, Ukraine**

L. Levchuk, S. Lukyanenko, D. Soroka, S. Zub

**University of Bristol, Bristol, United Kingdom**

F. Bostock, J.J. Brooke, T.L. Cheng, D. Cussans, R. Frazier, J. Goldstein, N. Grant, M. Hansen, G.P. Heath, H.F. Heath, C. Hill, B. Huckvale, J. Jackson, C.K. Mackay, S. Metson, D.M. Newbold<sup>33</sup>, K. Nirunpong, V.J. Smith, J. Velthuis, R. Walton

**Rutherford Appleton Laboratory, Didcot, United Kingdom**

K.W. Bell, C. Brew, R.M. Brown, B. Camanzi, D.J.A. Cockerill, J.A. Coughlan, N.I. Geddes, K. Harder, S. Harper, B.W. Kennedy, P. Murray, C.H. Shepherd-Themistocleous, I.R. Tomalin, J.H. Williams<sup>†</sup>, W.J. Womersley, S.D. Worm

**Imperial College, University of London, London, United Kingdom**

R. Bainbridge, G. Ball, J. Ballin, R. Beuselinck, O. Buchmuller, D. Colling, N. Cripps, G. Davies, M. Della Negra, C. Foudas, J. Fulcher, D. Futyan, G. Hall, J. Hays, G. Iles, G. Karapostoli, B.C. MacEvoy, A.-M. Magnan, J. Marrouche, J. Nash, A. Nikitenko<sup>24</sup>, A. Papageorgiou, M. Pesaresi, K. Petridis, M. Pioppi<sup>34</sup>, D.M. Raymond, N. Rompotis, A. Rose, M.J. Ryan, C. Seez, P. Sharp, G. Sidiropoulos<sup>1</sup>, M. Stettler, M. Stoye, M. Takahashi, A. Tapper, C. Timlin, S. Tourneur, M. Vazquez Acosta, T. Virdee<sup>1</sup>, S. Wakefield, D. Wardrope, T. Whyntie, M. Wingham

**Brunel University, Uxbridge, United Kingdom**

J.E. Cole, I. Goitom, P.R. Hobson, A. Khan, P. Kyberd, D. Leslie, C. Munro, I.D. Reid, C. Siamitros, R. Taylor, L. Teodorescu, I. Yaselli

**Boston University, Boston, U.S.A.**

T. Bose, M. Carleton, E. Hazen, A.H. Heering, A. Heister, J. St. John, P. Lawson, D. Lazic, D. Osborne, J. Rohlf, L. Sulak, S. Wu

**Brown University, Providence, U.S.A.**

J. Andrea, A. Avetisyan, S. Bhattacharya, J.P. Chou, D. Cutts, S. Esen, G. Kukartsev, G. Landsberg, M. Narain, D. Nguyen, T. Speer, K.V. Tsang

**University of California, Davis, Davis, U.S.A.**

R. Breedon, M. Calderon De La Barca Sanchez, M. Case, D. Cebra, M. Chertok, J. Conway, P.T. Cox, J. Dolen, R. Erbacher, E. Friis, W. Ko, A. Kopecky, R. Lander, A. Lister, H. Liu, S. Maruyama, T. Miceli, M. Nikolic, D. Pellett, J. Robles, M. Searle, J. Smith, M. Squires, J. Stilley, M. Tripathi, R. Vasquez Sierra, C. Veelken

**University of California, Los Angeles, Los Angeles, U.S.A.**

V. Andreev, K. Arisaka, D. Cline, R. Cousins, S. Erhan<sup>1</sup>, J. Hauser, M. Ignatenko, C. Jarvis, J. Mumford, C. Plager, G. Rakness, P. Schlein<sup>†</sup>, J. Tucker, V. Valuev, R. Wallny, X. Yang

**University of California, Riverside, Riverside, U.S.A.**

J. Babb, M. Bose, A. Chandra, R. Clare, J.A. Ellison, J.W. Gary, G. Hanson, G.Y. Jeng, S.C. Kao, F. Liu, H. Liu, A. Luthra, H. Nguyen, G. Pasztor<sup>35</sup>, A. Satpathy, B.C. Shen<sup>†</sup>, R. Stringer, J. Sturdy, V. Sytnik, R. Wilken, S. Wimpenny

**University of California, San Diego, La Jolla, U.S.A.**

J.G. Branson, E. Dusinger, D. Evans, F. Golf, R. Kelley, M. Lebourgeois, J. Letts, E. Lipeles, B. Mangano, J. Muelmenstaedt, M. Norman, S. Padhi, A. Petrucci, H. Pi, M. Pieri, R. Ranieri, M. Sani, V. Sharma, S. Simon, F. Würthwein, A. Yagil

**University of California, Santa Barbara, Santa Barbara, U.S.A.**

C. Campagnari, M. D'Alfonso, T. Danielson, J. Garberson, J. Incandela, C. Justus, P. Kalavase, S.A. Koay, D. Kovalskyi, V. Krutelyov, J. Lamb, S. Lowette, V. Pavlunin, F. Rebassoo, J. Ribnik, J. Richman, R. Rossin, D. Stuart, W. To, J.R. Vlimant, M. Witherell

**California Institute of Technology, Pasadena, U.S.A.**

A. Apresyan, A. Bornheim, J. Bunn, M. Chiorboli, M. Gataullin, D. Kcira, V. Litvine, Y. Ma, H.B. Newman, C. Rogan, V. Timciuc, J. Veverka, R. Wilkinson, Y. Yang, L. Zhang, K. Zhu, R.Y. Zhu

**Carnegie Mellon University, Pittsburgh, U.S.A.**

B. Akgun, R. Carroll, T. Ferguson, D.W. Jang, S.Y. Jun, M. Paulini, J. Russ, N. Terentyev, H. Vogel, I. Vorobiev

**University of Colorado at Boulder, Boulder, U.S.A.**

J.P. Cumalat, M.E. Dinardo, B.R. Drell, W.T. Ford, B. Heyburn, E. Luiggi Lopez, U. Nauenberg, K. Stenson, K. Ulmer, S.R. Wagner, S.L. Zang

**Cornell University, Ithaca, U.S.A.**

L. Agostino, J. Alexander, F. Blekman, D. Cassel, A. Chatterjee, S. Das, L.K. Gibbons, B. Heltsley, W. Hopkins, A. Khukhunaishvili, B. Kreis, V. Kuznetsov, J.R. Patterson, D. Puigh, A. Ryd, X. Shi, S. Stoinev, W. Sun, W.D. Teo, J. Thom, J. Vaughan, Y. Weng, P. Wittich

**Fairfield University, Fairfield, U.S.A.**

C.P. Beetz, G. Cirino, C. Sanzeni, D. Winn

**Fermi National Accelerator Laboratory, Batavia, U.S.A.**

S. Abdullin, M.A. Afaq<sup>1</sup>, M. Albrow, B. Ananthan, G. Apollinari, M. Atac, W. Badgett, L. Bagby, J.A. Bakken, B. Baldin, S. Banerjee, K. Banicz, L.A.T. Bauerdick, A. Beretvas, J. Berryhill, P.C. Bhat, K. Biery, M. Binkley, I. Bloch, F. Borcherding, A.M. Brett, K. Burkett, J.N. Butler, V. Chetluru, H.W.K. Cheung, F. Chlebana, I. Churin, S. Cihangir, M. Crawford, W. Dagenhart, M. Demarteau, G. Derylo, D. Dykstra, D.P. Eartly, J.E. Elias, V.D. Elvira, D. Evans, L. Feng, M. Fischler, I. Fisk, S. Foulkes, J. Freeman, P. Gartung, E. Gottschalk, T. Grassi, D. Green, Y. Guo, O. Gutsche, A. Hahn, J. Hanlon, R.M. Harris, B. Holzman, J. Howell, D. Hufnagel, E. James, H. Jensen, M. Johnson, C.D. Jones, U. Joshi, E. Juska, J. Kaiser, B. Klima, S. Kossiakov, K. Kousouris, S. Kwan, C.M. Lei, P. Limon, J.A. Lopez Perez, S. Los, L. Lueking, G. Lukhanin, S. Lusin<sup>1</sup>, J. Lykken, K. Maeshima, J.M. Marraffino, D. Mason, P. McBride, T. Miao, K. Mishra, S. Moccia, R. Mommsen, S. Mrenna, A.S. Muhammad, C. Newman-Holmes, C. Noeding, V. O'Dell, O. Prokofyev, R. Rivera, C.H. Rivetta, A. Ronzhin, P. Rossman, S. Ryu, V. Sekhri, E. Sexton-Kennedy, I. Sfiligoi, S. Sharma, T.M. Shaw, D. Shpakov, E. Skup, R.P. Smith<sup>†</sup>, A. Soha, W.J. Spalding, L. Spiegel, I. Suzuki, P. Tan, W. Tanenbaum, S. Tkaczyk<sup>1</sup>, R. Trentadue<sup>1</sup>, L. Uplegger, E.W. Vaandering, R. Vidal, J. Whitmore, E. Wicklund, W. Wu, J. Yarba, F. Yumiceva, J.C. Yun

**University of Florida, Gainesville, U.S.A.**

D. Acosta, P. Avery, V. Barashko, D. Bourilkov, M. Chen, G.P. Di Giovanni, D. Dobur, A. Drozdetskiy, R.D. Field, Y. Fu, I.K. Furic, J. Gartner, D. Holmes, B. Kim, S. Klimenko, J. Konigsberg, A. Korytov, K. Kotov, A. Kropivnitskaya, T. Kypreos, A. Madorsky, K. Matchev, G. Mitselmakher, Y. Pakhotin, J. Piedra Gomez, C. Prescott, V. Rapsevicius, R. Remington, M. Schmitt, B. Scurlock, D. Wang, J. Yelton

**Florida International University, Miami, U.S.A.**

C. Ceron, V. Gaultney, L. Kramer, L.M. Lebolo, S. Linn, P. Markowitz, G. Martinez, J.L. Rodriguez

**Florida State University, Tallahassee, U.S.A.**

T. Adams, A. Askew, H. Baer, M. Bertoldi, J. Chen, W.G.D. Dharmaratna, S.V. Gleyzer, J. Haas, S. Hagopian, V. Hagopian, M. Jenkins, K.F. Johnson, E. Prettnner, H. Prosper, S. Sekmen

**Florida Institute of Technology, Melbourne, U.S.A.**

M.M. Baarmand, S. Guragain, M. Hohlmann, H. Kalakhety, H. Mermerkaya, R. Ralich, I. Vodopyanov

**University of Illinois at Chicago (UIC), Chicago, U.S.A.**

B. Abelev, M.R. Adams, I.M. Anghel, L. Apanasevich, V.E. Bazterra, R.R. Betts, J. Callner, M.A. Castro, R. Cavanaugh, C. Dragoiu, E.J. Garcia-Solis, C.E. Gerber, D.J. Hofman, S. Khalatian, C. Mironov, E. Shabalina, A. Smoron, N. Varelas

**The University of Iowa, Iowa City, U.S.A.**

U. Akgun, E.A. Albayrak, A.S. Ayan, B. Bilki, R. Briggs, K. Cankocak<sup>36</sup>, K. Chung, W. Clarida, P. Debbins, F. Duru, F.D. Ingram, C.K. Lae, E. McCliment, J.-P. Merlo, A. Mestvirishvili, M.J. Miller, A. Moeller, J. Nachtman, C.R. Newsom, E. Norbeck, J. Olson, Y. Onel, F. Ozok, J. Parsons, I. Schmidt, S. Sen, J. Wetzel, T. Yetkin, K. Yi

**Johns Hopkins University, Baltimore, U.S.A.**

B.A. Barnett, B. Blumenfeld, A. Bonato, C.Y. Chien, D. Fehling, G. Giurgiu, A.V. Gritsan, Z.J. Guo, P. Maksimovic, S. Rappoccio, M. Swartz, N.V. Tran, Y. Zhang

**The University of Kansas, Lawrence, U.S.A.**

P. Baringer, A. Bean, O. Grachov, M. Murray, V. Radicci, S. Sanders, J.S. Wood, V. Zhukova

**Kansas State University, Manhattan, U.S.A.**

D. Bandurin, T. Bolton, K. Kaadze, A. Liu, Y. Maravin, D. Onoprienko, I. Svintradze, Z. Wan

**Lawrence Livermore National Laboratory, Livermore, U.S.A.**

J. Gronberg, J. Hollar, D. Lange, D. Wright

**University of Maryland, College Park, U.S.A.**

D. Baden, R. Bard, M. Boutemour, S.C. Eno, D. Ferencek, N.J. Hadley, R.G. Kellogg, M. Kirn, S. Kunori, K. Rossato, P. Rumerio, F. Santanastasio, A. Skuja, J. Temple, M.B. Tonjes, S.C. Tonwar, T. Toole, E. Twedt

**Massachusetts Institute of Technology, Cambridge, U.S.A.**

B. Alver, G. Bauer, J. Bendavid, W. Busza, E. Butz, I.A. Cali, M. Chan, D. D'Enterria, P. Everaerts, G. Gomez Ceballos, K.A. Hahn, P. Harris, S. Jaditz, Y. Kim, M. Klute, Y.-J. Lee, W. Li, C. Loizides, T. Ma, M. Miller, S. Nahn, C. Paus, C. Roland, G. Roland, M. Rudolph, G. Stephans, K. Sumorok, K. Sung, S. Vaurynovich, E.A. Wenger, B. Wyslouch, S. Xie, Y. Yilmaz, A.S. Yoon

**University of Minnesota, Minneapolis, U.S.A.**

D. Bailleux, S.I. Cooper, P. Cushman, B. Dahmes, A. De Benedetti, A. Dolgoplov, P.R. Duderov, R. Egeland, G. Franzoni, J. Haupt, A. Inyakin<sup>37</sup>, K. Klapoetke, Y. Kubota, J. Mans, N. Mirman, D. Petyt, V. Rekovic, R. Rusack, M. Schroeder, A. Singovsky, J. Zhang

**University of Mississippi, University, U.S.A.**

L.M. Cremaldi, R. Godang, R. Kroeger, L. Perera, R. Rahmat, D.A. Sanders, P. Sonnek, D. Summers

**University of Nebraska-Lincoln, Lincoln, U.S.A.**

K. Bloom, B. Bockelman, S. Bose, J. Butt, D.R. Claes, A. Dominguez, M. Eads, J. Keller, T. Kelly, I. Kravchenko, J. Lazo-Flores, C. Lundstedt, H. Malbouisson, S. Malik, G.R. Snow

**State University of New York at Buffalo, Buffalo, U.S.A.**

U. Baur, I. Iashvili, A. Kharchilava, A. Kumar, K. Smith, M. Strang

**Northeastern University, Boston, U.S.A.**

G. Alverson, E. Barberis, O. Boeriu, G. Eulisse, G. Govi, T. McCauley, Y. Musienko<sup>38</sup>, S. Muzaffar, I. Osborne, T. Paul, S. Reucroft, J. Swain, L. Taylor, L. Tuura

**Northwestern University, Evanston, U.S.A.**

A. Anastassov, B. Gobbi, A. Kubik, R.A. Ofierzynski, A. Pozdnyakov, M. Schmitt, S. Stoynev, M. Velasco, S. Won

**University of Notre Dame, Notre Dame, U.S.A.**

L. Antonelli, D. Berry, M. Hildreth, C. Jessop, D.J. Karmgard, T. Kolberg, K. Lannon, S. Lynch, N. Marinelli, D.M. Morse, R. Ruchti, J. Slaunwhite, J. Warchol, M. Wayne

**The Ohio State University, Columbus, U.S.A.**

B. Bylsma, L.S. Durkin, J. Gilmore<sup>39</sup>, J. Gu, P. Killewald, T.Y. Ling, G. Williams

**Princeton University, Princeton, U.S.A.**

N. Adam, E. Berry, P. Elmer, A. Garmash, D. Gerbaudo, V. Halyo, A. Hunt, J. Jones, E. Laird, D. Marlow, T. Medvedeva, M. Mooney, J. Olsen, P. Piroué, D. Stickland, C. Tully, J.S. Werner, T. Wildish, Z. Xie, A. Zuranski

**University of Puerto Rico, Mayaguez, U.S.A.**

J.G. Acosta, M. Bonnett Del Alamo, X.T. Huang, A. Lopez, H. Mendez, S. Oliveros, J.E. Ramirez Vargas, N. Santacruz, A. Zatzerklyany

**Purdue University, West Lafayette, U.S.A.**

E. Alagoz, E. Antillon, V.E. Barnes, G. Bolla, D. Bortoletto, A. Everett, A.F. Garfinkel, Z. Gecse, L. Gutay, N. Ippolito, M. Jones, O. Koybasi, A.T. Laasanen, N. Leonardo, C. Liu, V. Maroussov, P. Merkel, D.H. Miller, N. Neumeister, A. Sedov, I. Shipsey, H.D. Yoo, Y. Zheng

**Purdue University Calumet, Hammond, U.S.A.**

P. Jindal, N. Parashar

**Rice University, Houston, U.S.A.**

V. Cuplov, K.M. Ecklund, F.J.M. Geurts, J.H. Liu, D. Maronde, M. Matveev, B.P. Padley, R. Redjimi, J. Roberts, L. Sabbatini, A. Tumanov

**University of Rochester, Rochester, U.S.A.**

B. Betchart, A. Bodek, H. Budd, Y.S. Chung, P. de Barbaro, R. Demina, H. Flacher, Y. Gotra, A. Harel, S. Korjenevski, D.C. Miner, D. Orbaker, G. Petrillo, D. Vishnevskiy, M. Zielinski

**The Rockefeller University, New York, U.S.A.**

A. Bhatti, L. Demortier, K. Goulios, K. Hatakeyama, G. Lungu, C. Mesropian, M. Yan

**Rutgers, the State University of New Jersey, Piscataway, U.S.A.**

O. Atramentov, E. Bartz, Y. Gershtein, E. Halkiadakis, D. Hits, A. Lath, K. Rose, S. Schnetzer, S. Somalwar, R. Stone, S. Thomas, T.L. Watts

**University of Tennessee, Knoxville, U.S.A.**

G. Cerizza, M. Hollingsworth, S. Spanier, Z.C. Yang, A. York

**Texas A&M University, College Station, U.S.A.**

J. Asaadi, A. Aurisano, R. Eusebi, A. Golyash, A. Gurrola, T. Kamon, C.N. Nguyen, J. Pivarski, A. Safonov, S. Sengupta, D. Toback, M. Weinberger

**Texas Tech University, Lubbock, U.S.A.**

N. Akchurin, L. Berntzon, K. Gumus, C. Jeong, H. Kim, S.W. Lee, S. Popescu, Y. Roh, A. Sill, I. Volobouev, E. Washington, R. Wigmans, E. Yazgan

**Vanderbilt University, Nashville, U.S.A.**

D. Engh, C. Florez, W. Johns, S. Pathak, P. Sheldon

**University of Virginia, Charlottesville, U.S.A.**

D. Andelin, M.W. Arenton, M. Balazs, S. Boutle, M. Buehler, S. Conetti, B. Cox, R. Hirosky, A. Ledovskoy, C. Neu, D. Phillips II, M. Ronquest, R. Yohay

**Wayne State University, Detroit, U.S.A.**

S. Gollapinni, K. Gunthoti, R. Harr, P.E. Karchin, M. Mattson, A. Sakharov

**University of Wisconsin, Madison, U.S.A.**

M. Anderson, M. Bachtis, J.N. Bellinger, D. Carlsmith, I. Crotty<sup>1</sup>, S. Dasu, S. Dutta, J. Efron, F. Feyzi, K. Flood, L. Gray, K.S. Grogg, M. Grothe, R. Hall-Wilton<sup>1</sup>, M. Jaworski, P. Klabbers, J. Klukas, A. Lanaro, C. Lazaridis, J. Leonard, R. Loveless, M. Magrans de Abril, A. Mohapatra, G. Ott, G. Polese, D. Reeder, A. Savin, W.H. Smith, A. Sourkov<sup>40</sup>, J. Swanson, M. Weinberg, D. Wenman, M. Wensveen, A. White

†: Deceased

- 1: Also at CERN, European Organization for Nuclear Research, Geneva, Switzerland
- 2: Also at Universidade Federal do ABC, Santo Andre, Brazil
- 3: Also at Soltan Institute for Nuclear Studies, Warsaw, Poland
- 4: Also at Université de Haute-Alsace, Mulhouse, France
- 5: Also at Centre de Calcul de l'Institut National de Physique Nucleaire et de Physique des Particules (IN2P3), Villeurbanne, France
- 6: Also at Moscow State University, Moscow, Russia
- 7: Also at Institute of Nuclear Research ATOMKI, Debrecen, Hungary
- 8: Also at University of California, San Diego, La Jolla, U.S.A.
- 9: Also at Tata Institute of Fundamental Research - HECR, Mumbai, India
- 10: Also at University of Visva-Bharati, Santiniketan, India
- 11: Also at Facolta' Ingegneria Universita' di Roma "La Sapienza", Roma, Italy
- 12: Also at Università della Basilicata, Potenza, Italy
- 13: Also at Laboratori Nazionali di Legnaro dell' INFN, Legnaro, Italy
- 14: Also at Università di Trento, Trento, Italy
- 15: Also at ENEA - Casaccia Research Center, S. Maria di Galeria, Italy
- 16: Also at Warsaw University of Technology, Institute of Electronic Systems, Warsaw, Poland
- 17: Also at California Institute of Technology, Pasadena, U.S.A.
- 18: Also at Faculty of Physics of University of Belgrade, Belgrade, Serbia
- 19: Also at Laboratoire Leprince-Ringuet, Ecole Polytechnique, IN2P3-CNRS, Palaiseau, France
- 20: Also at Alstom Contracting, Geneve, Switzerland
- 21: Also at Scuola Normale e Sezione dell' INFN, Pisa, Italy
- 22: Also at University of Athens, Athens, Greece
- 23: Also at The University of Kansas, Lawrence, U.S.A.
- 24: Also at Institute for Theoretical and Experimental Physics, Moscow, Russia
- 25: Also at Paul Scherrer Institut, Villigen, Switzerland
- 26: Also at Vinca Institute of Nuclear Sciences, Belgrade, Serbia
- 27: Also at University of Wisconsin, Madison, U.S.A.
- 28: Also at Mersin University, Mersin, Turkey
- 29: Also at Izmir Institute of Technology, Izmir, Turkey
- 30: Also at Kafkas University, Kars, Turkey
- 31: Also at Suleyman Demirel University, Isparta, Turkey
- 32: Also at Ege University, Izmir, Turkey

- 33: Also at Rutherford Appleton Laboratory, Didcot, United Kingdom
- 34: Also at INFN Sezione di Perugia; Universita di Perugia, Perugia, Italy
- 35: Also at KFKI Research Institute for Particle and Nuclear Physics, Budapest, Hungary
- 36: Also at Istanbul Technical University, Istanbul, Turkey
- 37: Also at University of Minnesota, Minneapolis, U.S.A.
- 38: Also at Institute for Nuclear Research, Moscow, Russia
- 39: Also at Texas A&M University, College Station, U.S.A.
- 40: Also at State Research Center of Russian Federation, Institute for High Energy Physics, Protvino, Russia